

SEZIONE TIPO OUTDOOR SU PAU

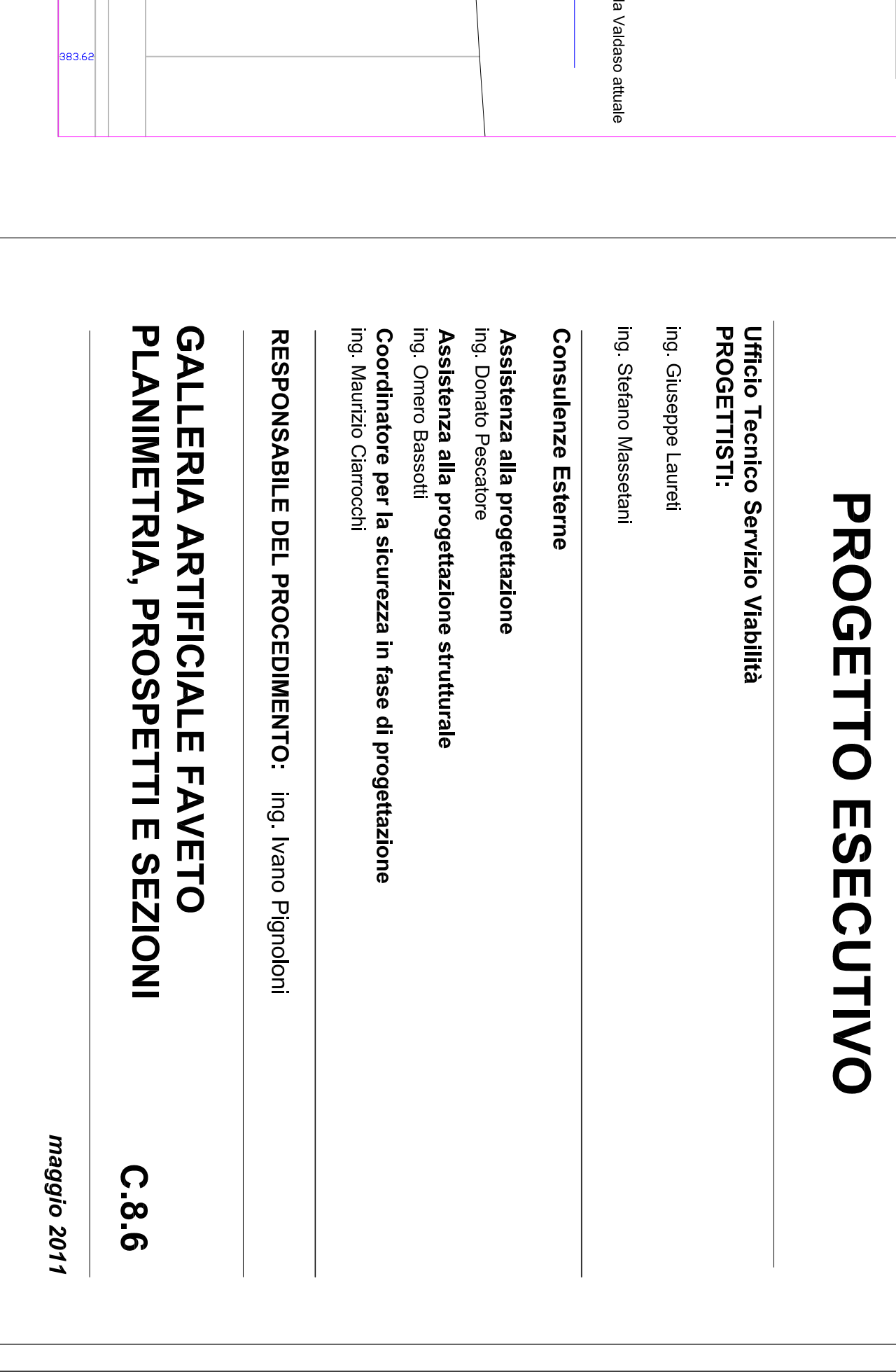

PARADIGMA PROGETTO

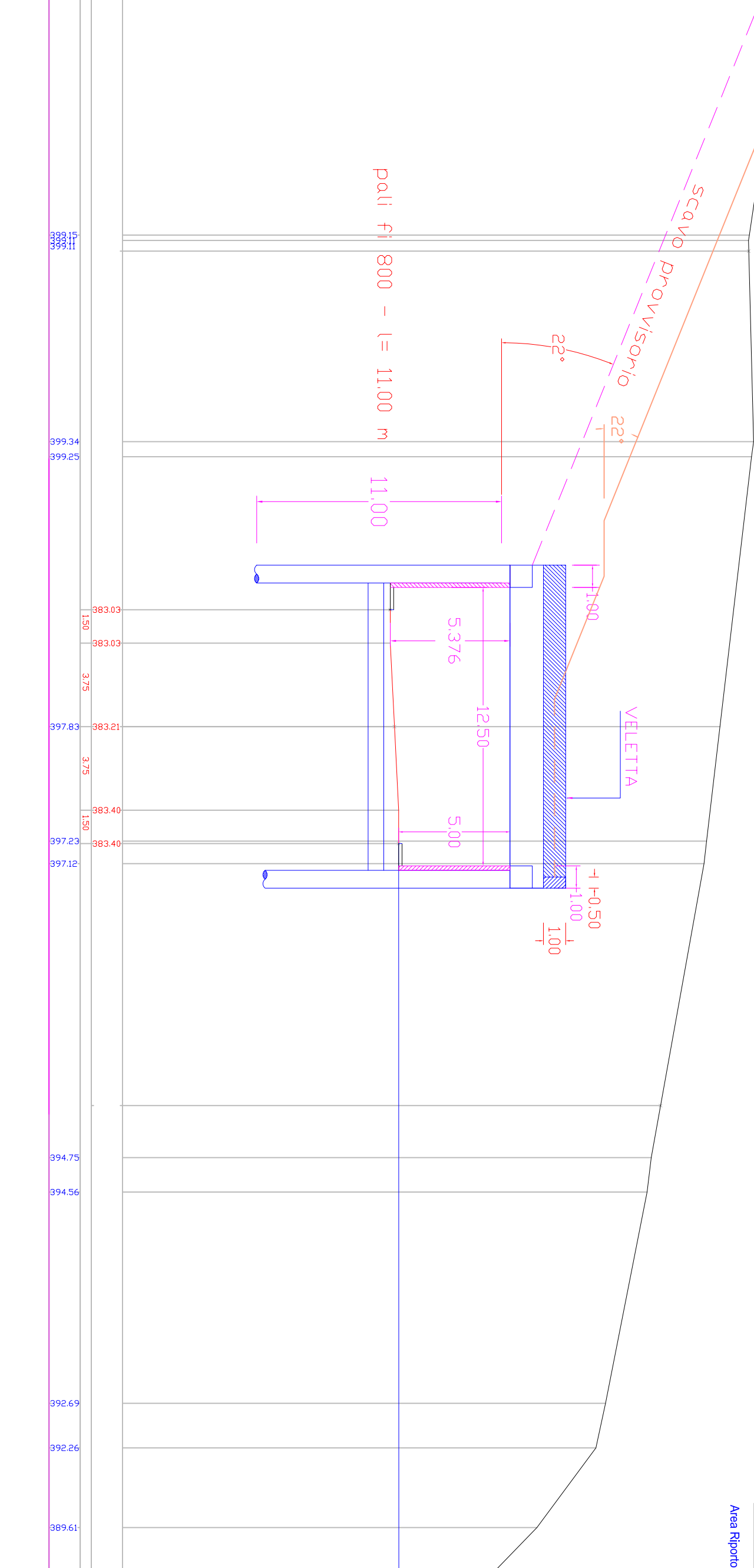
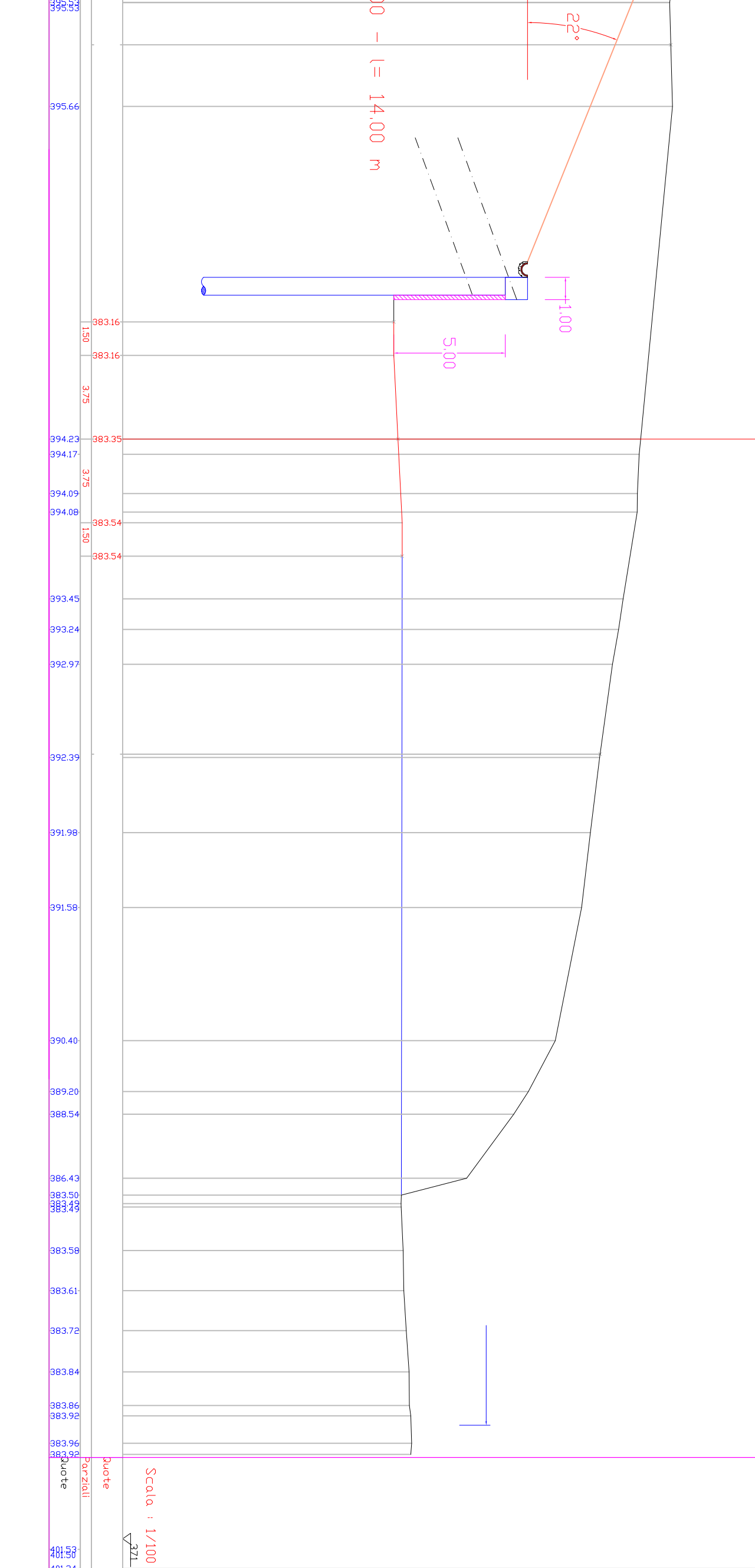
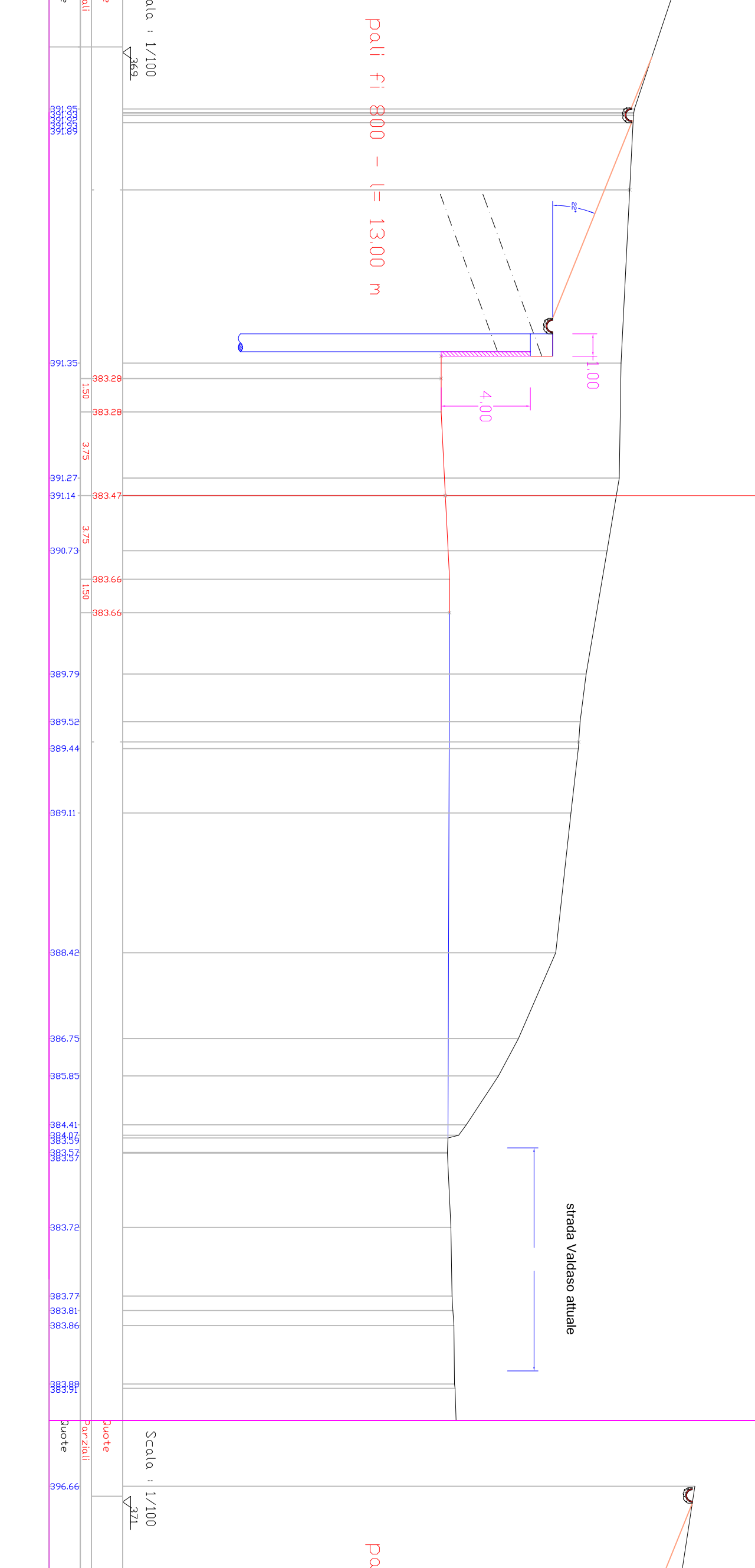
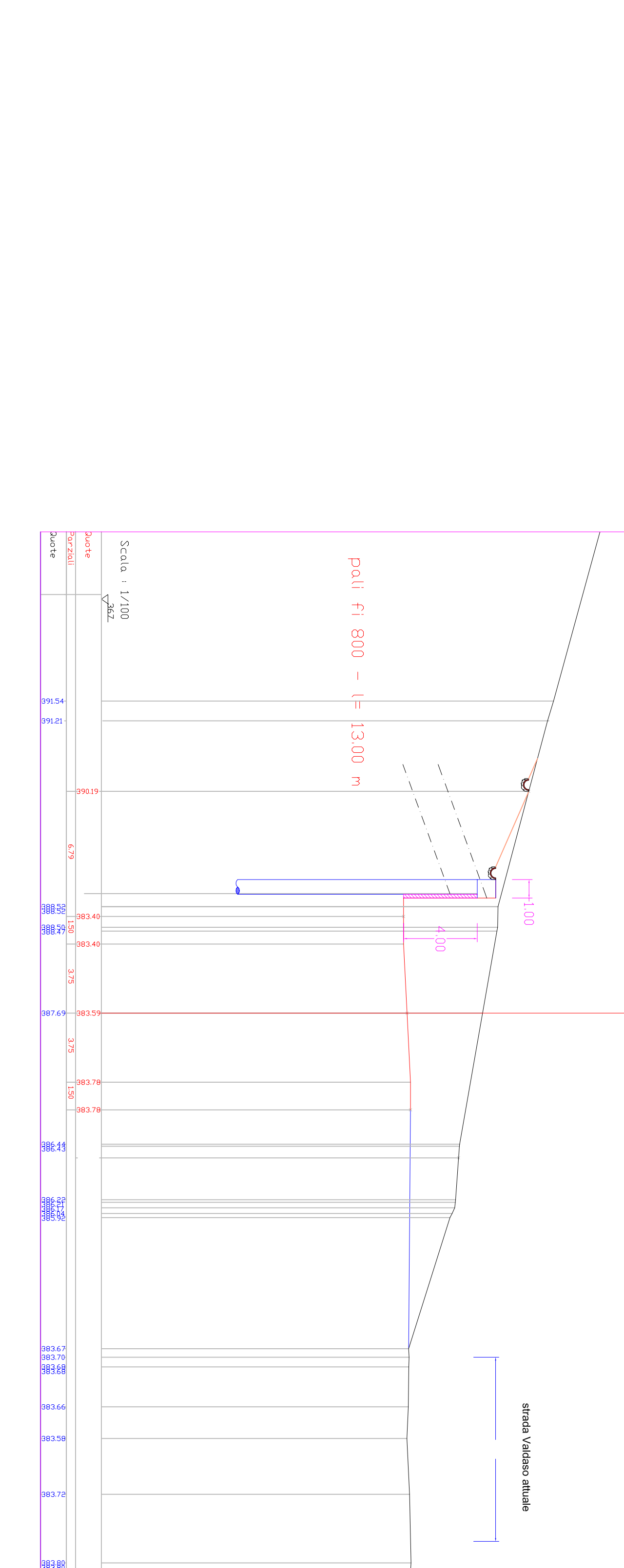
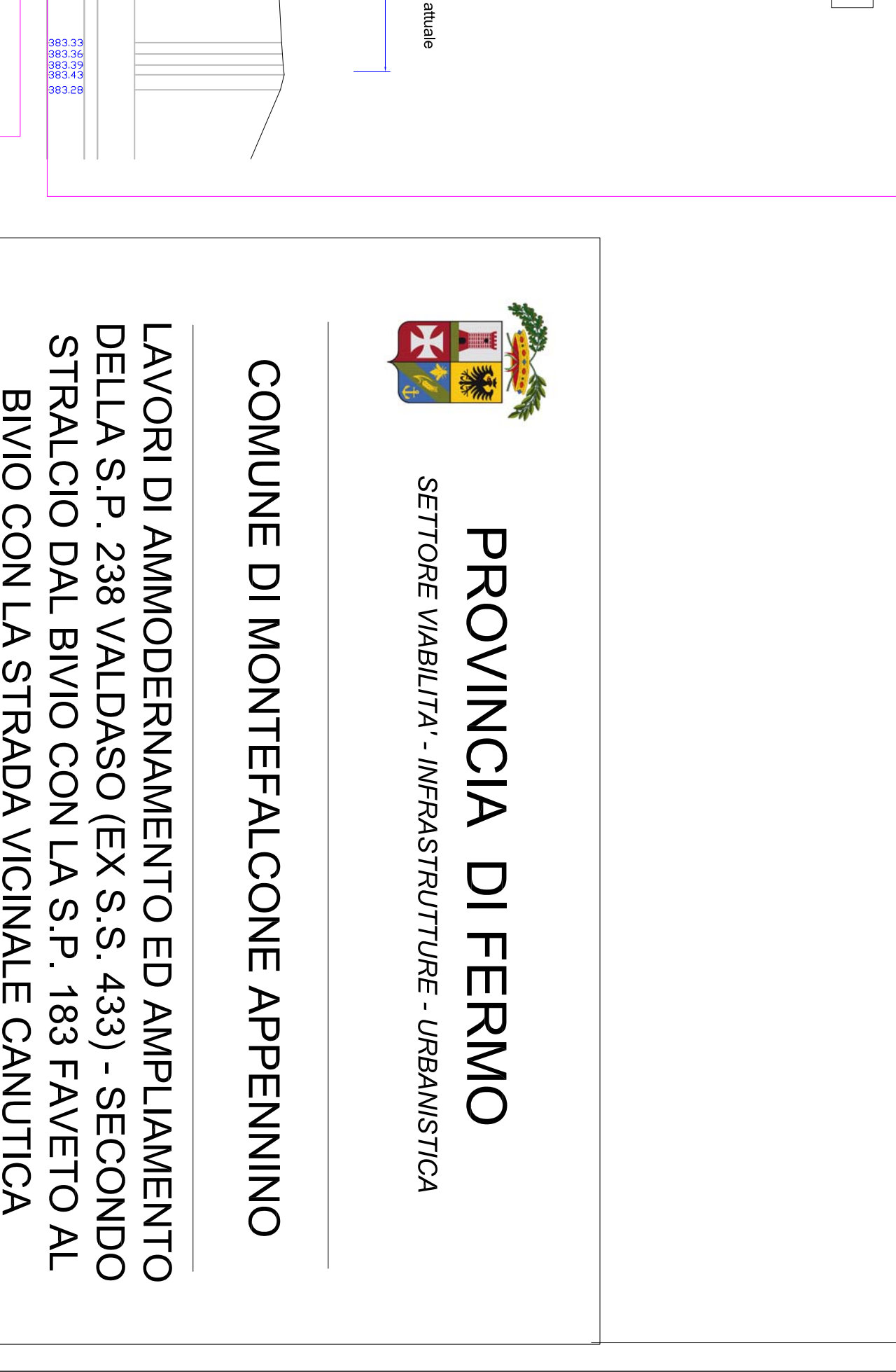
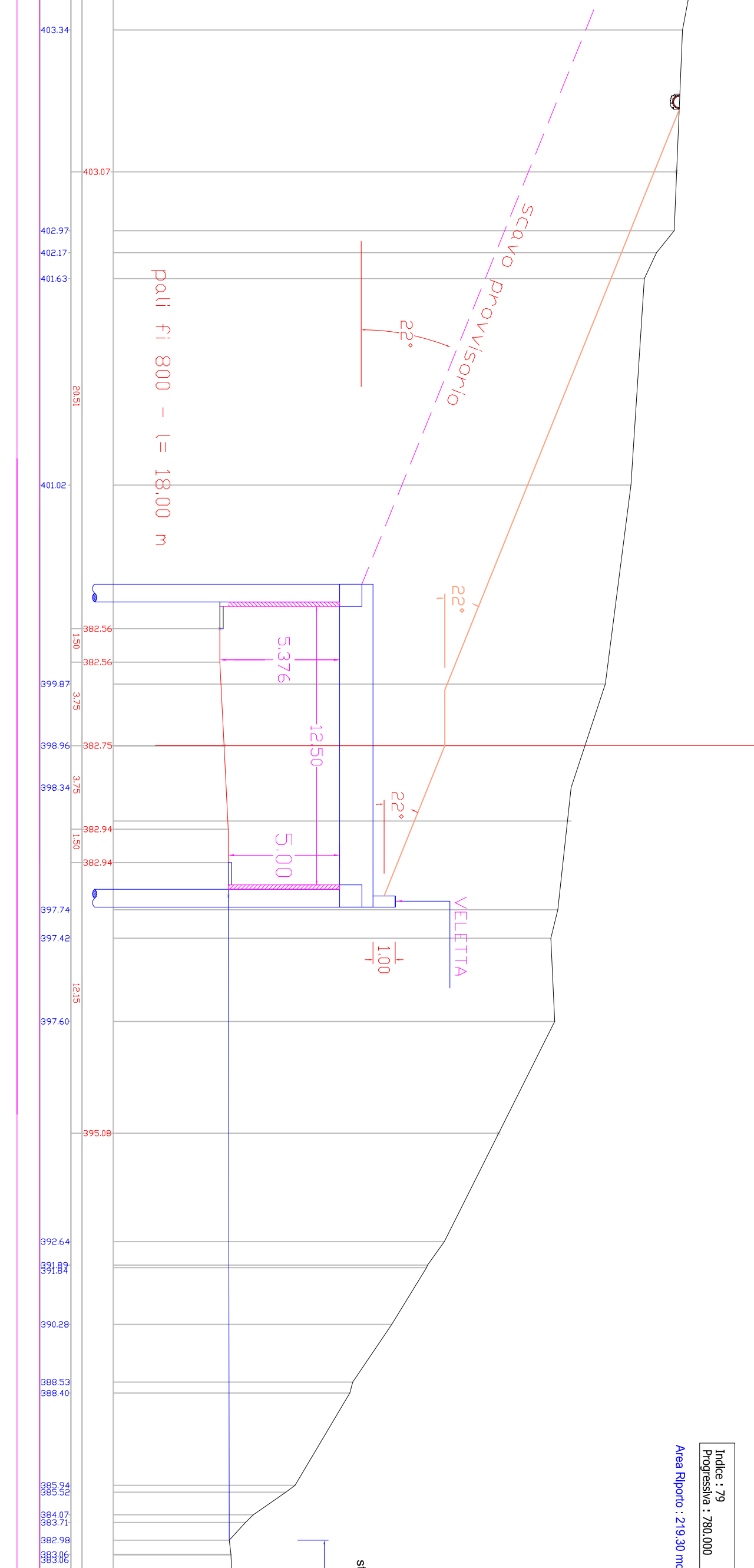
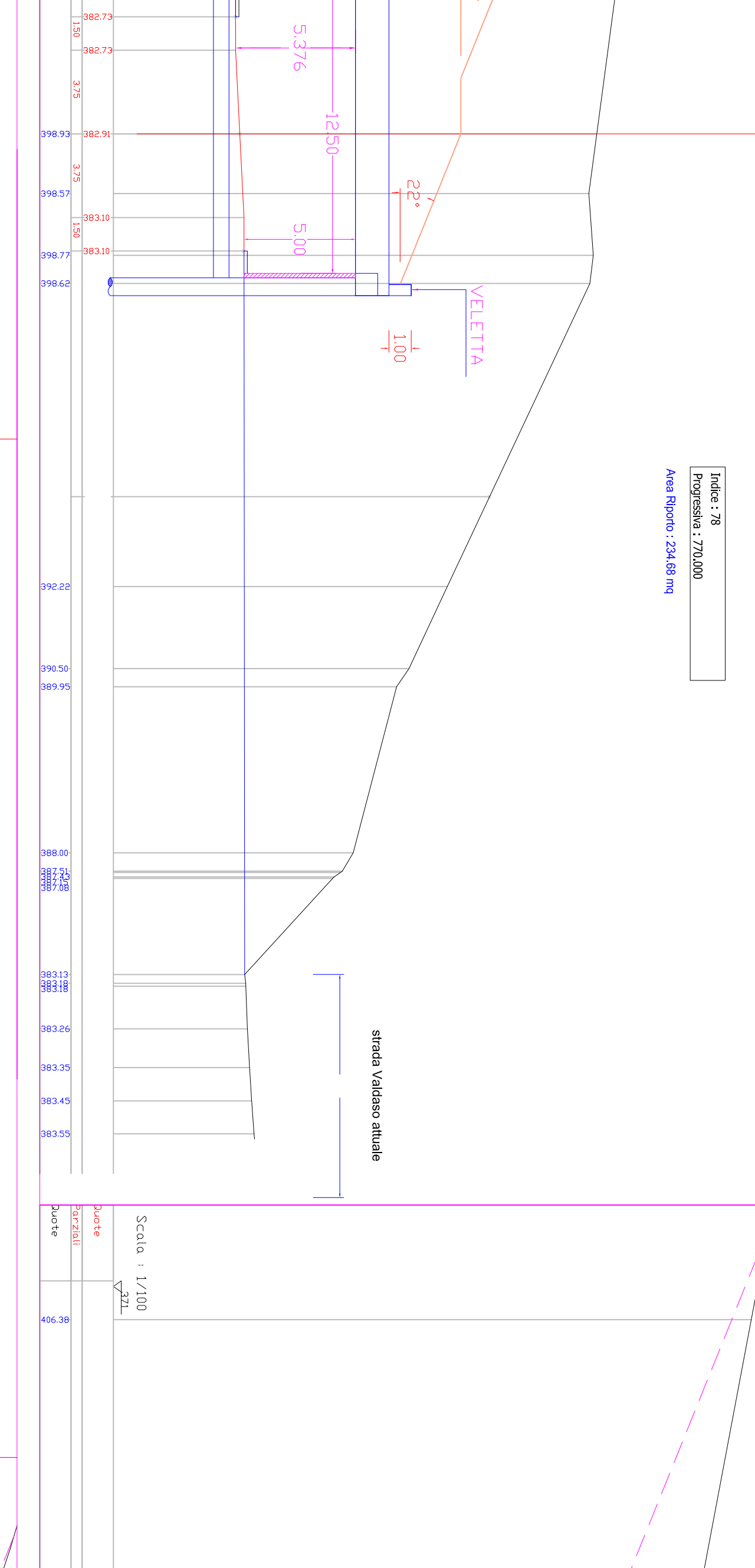
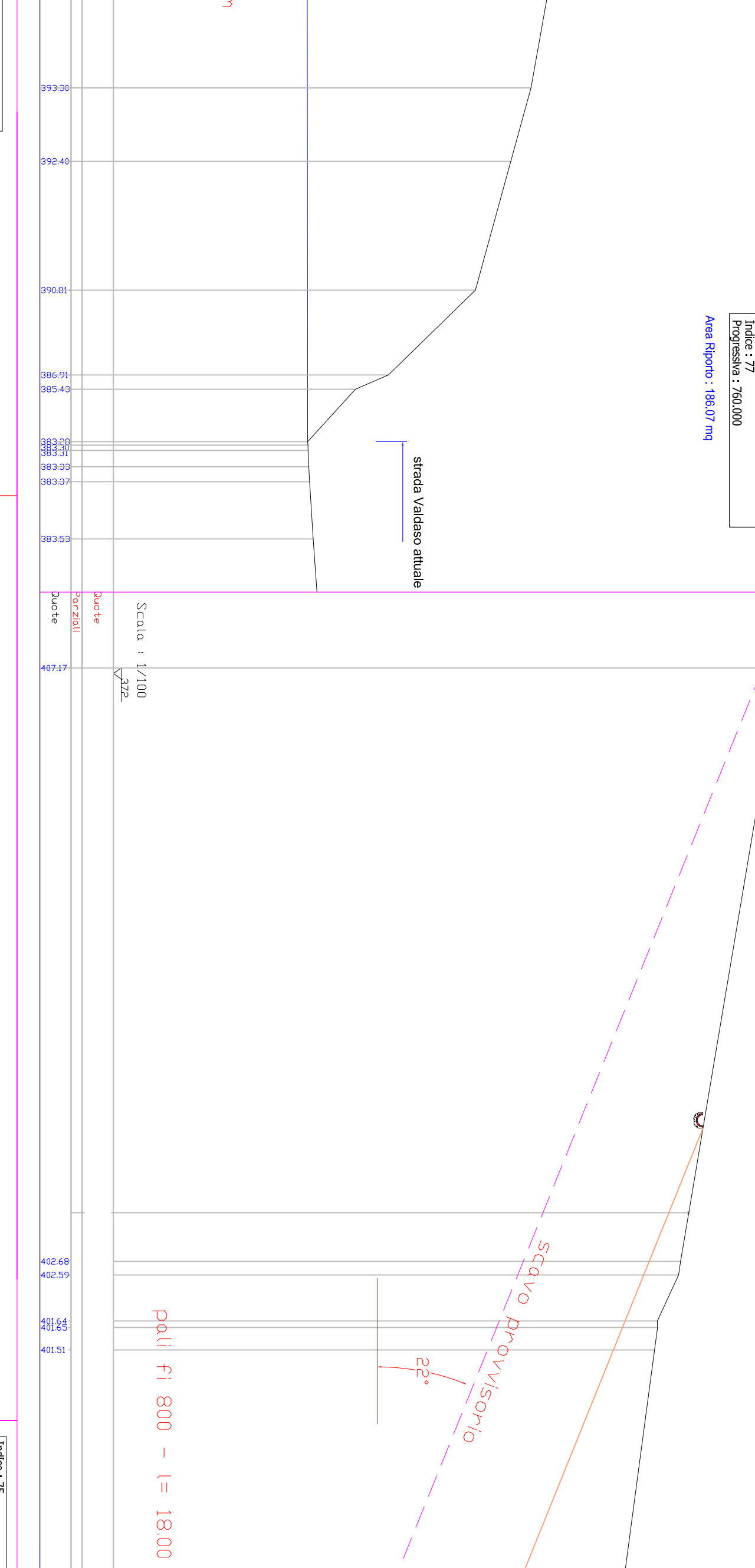
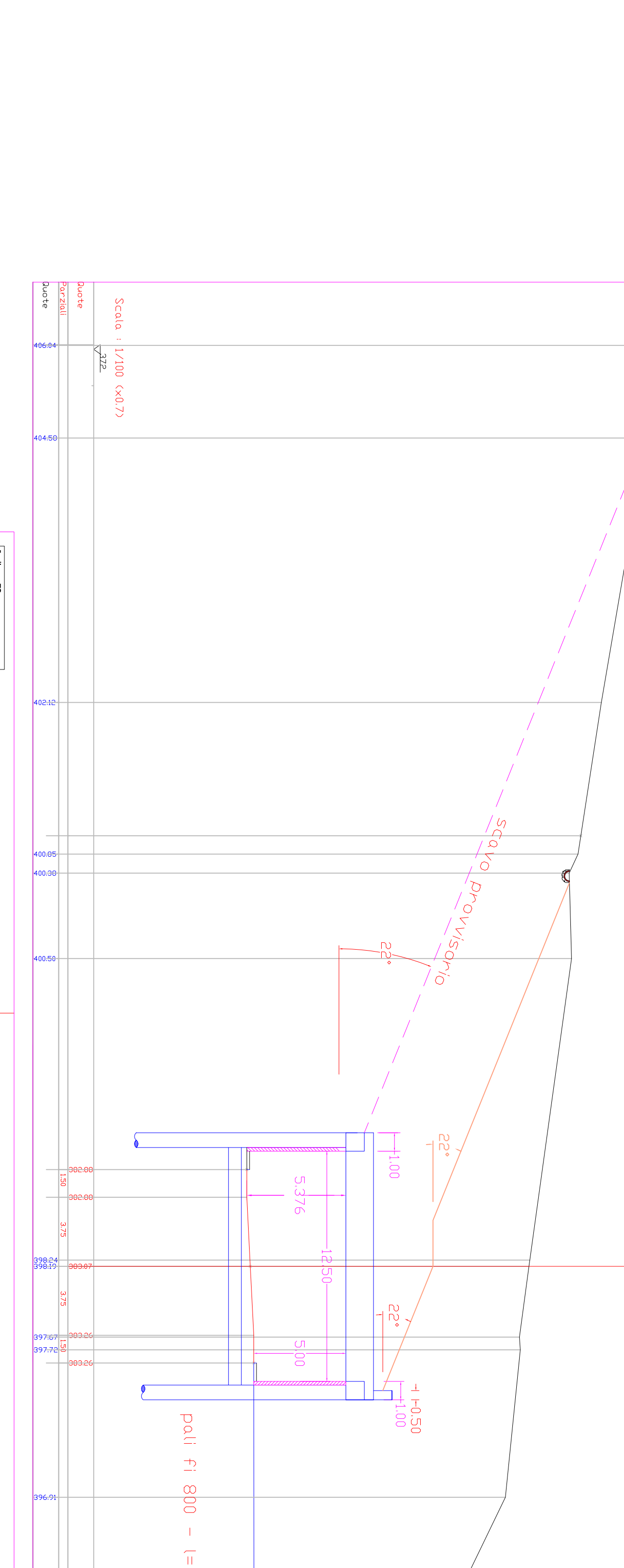
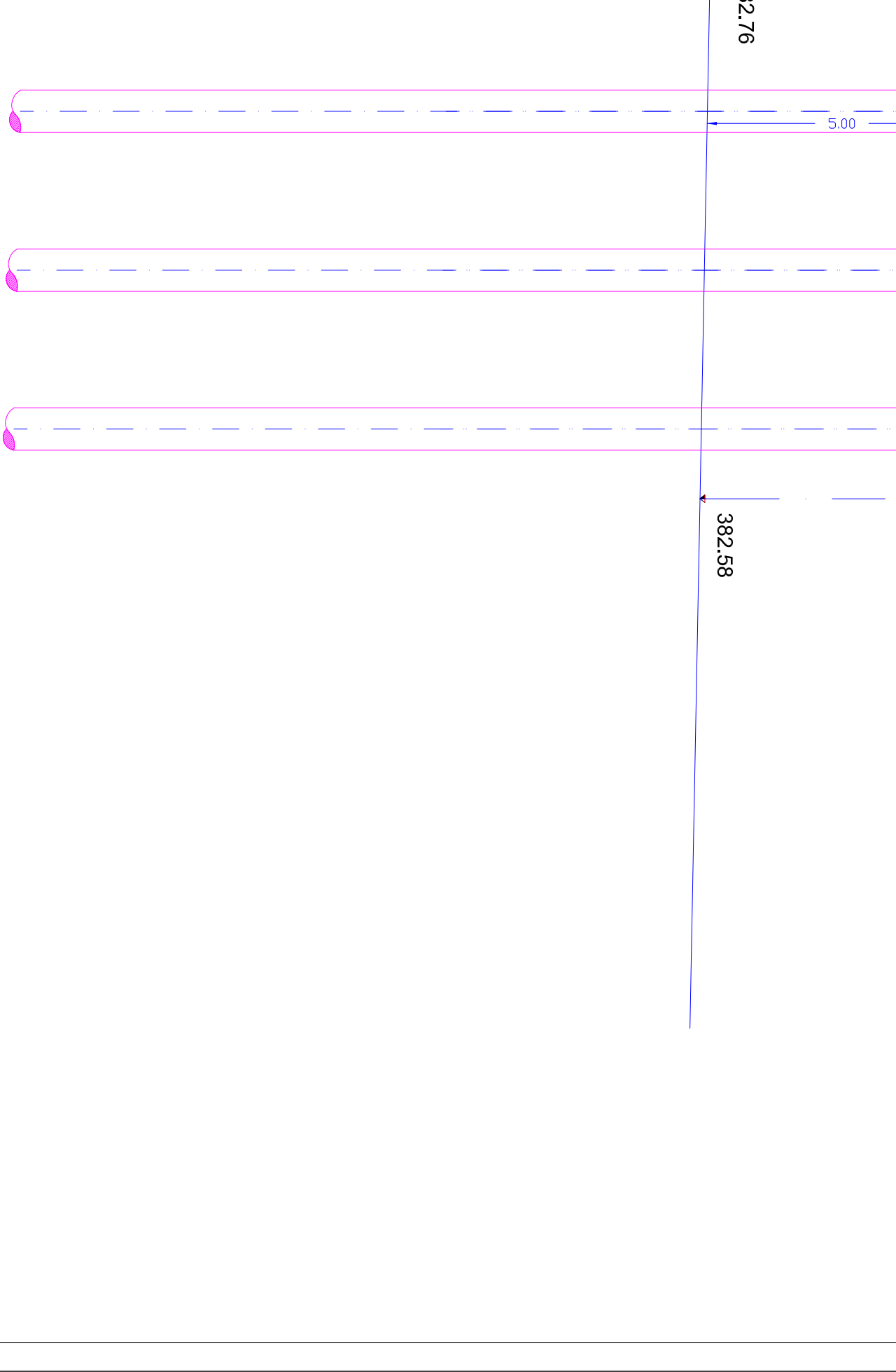
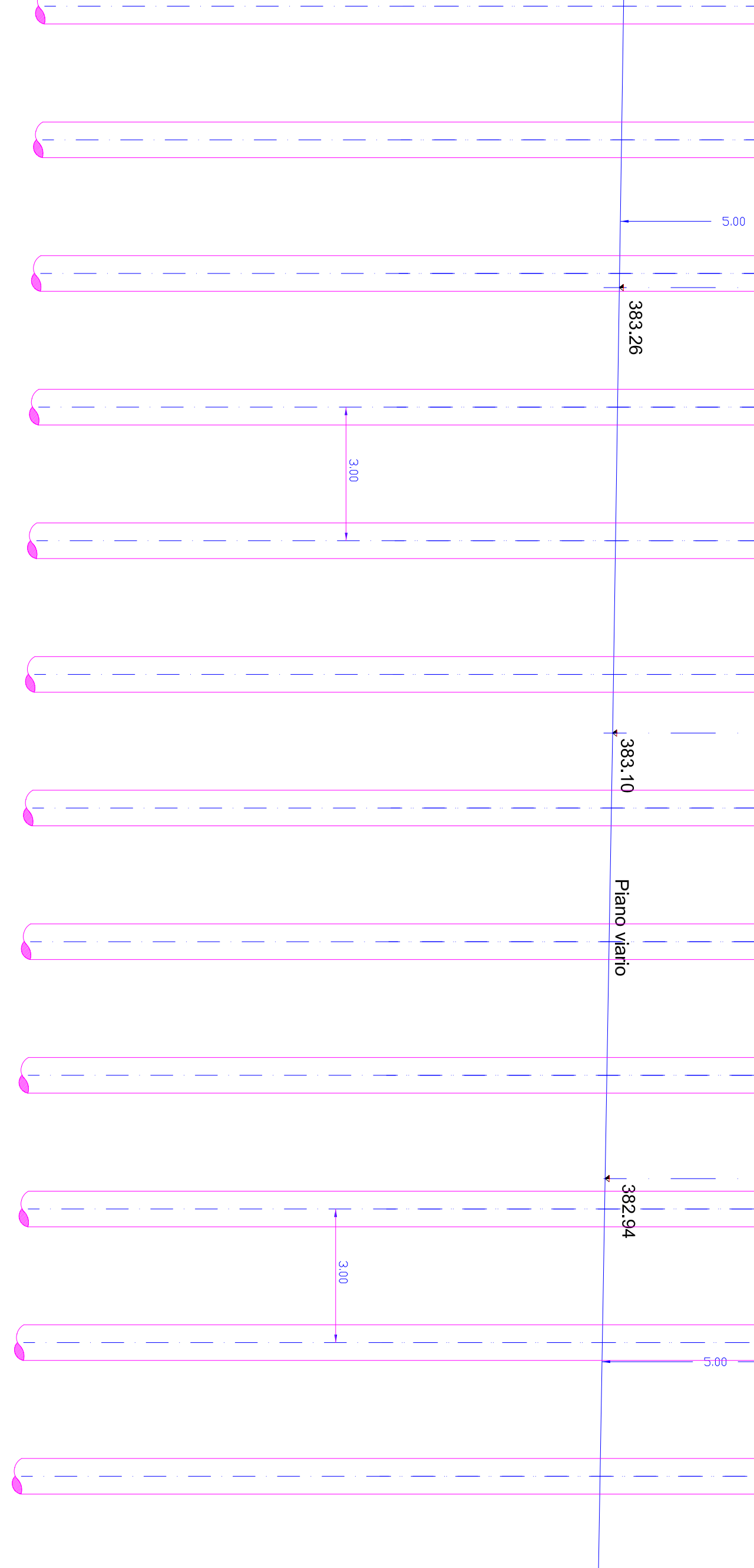
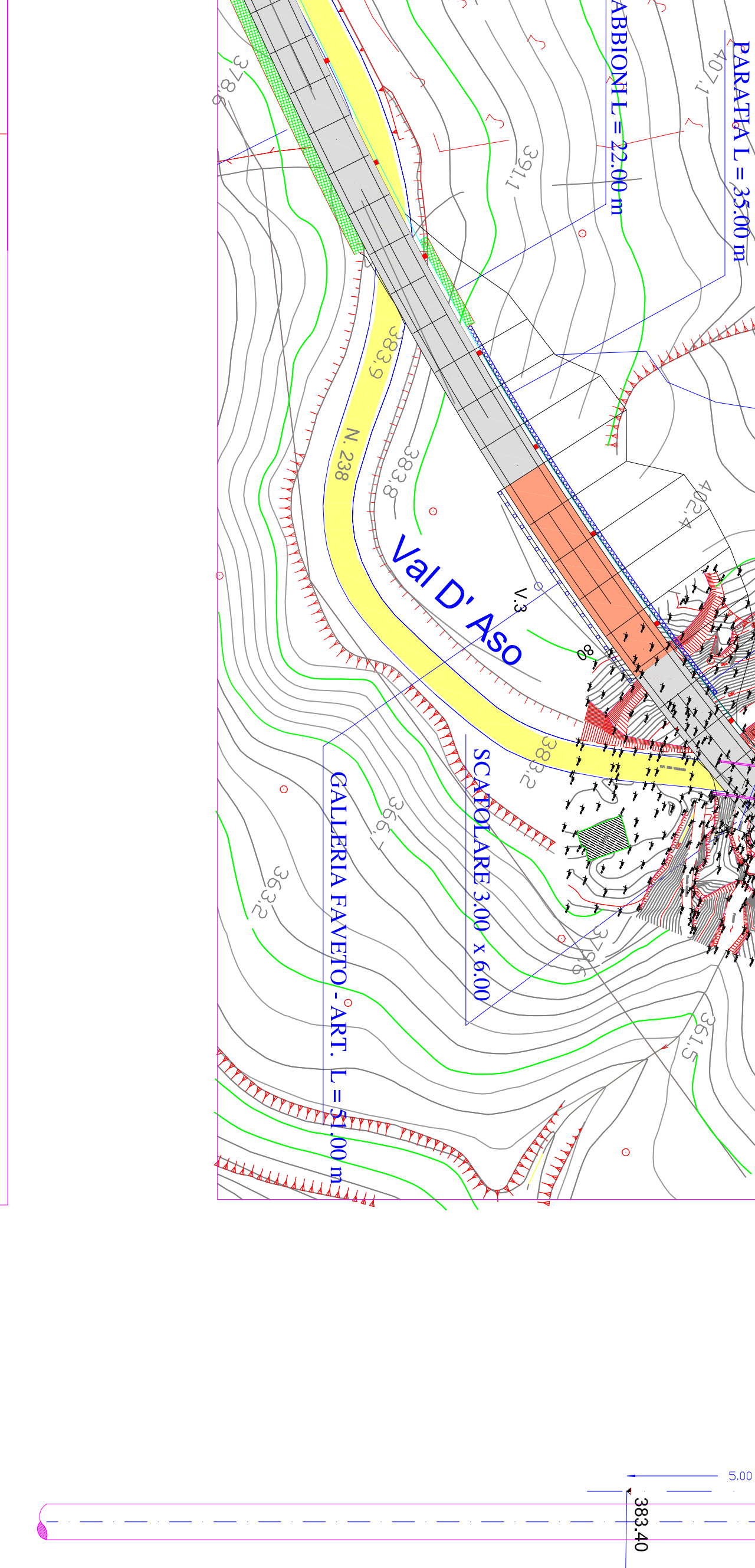
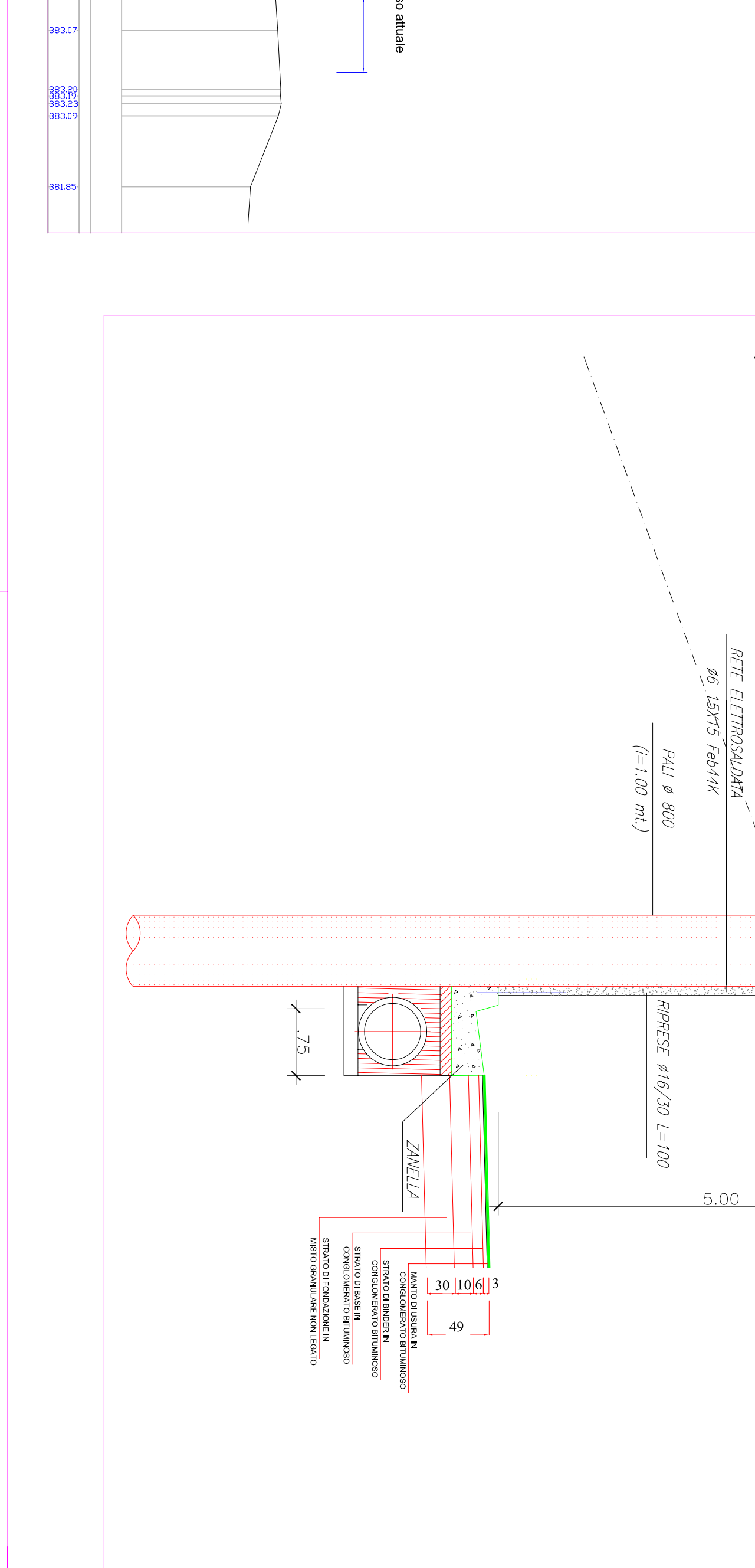
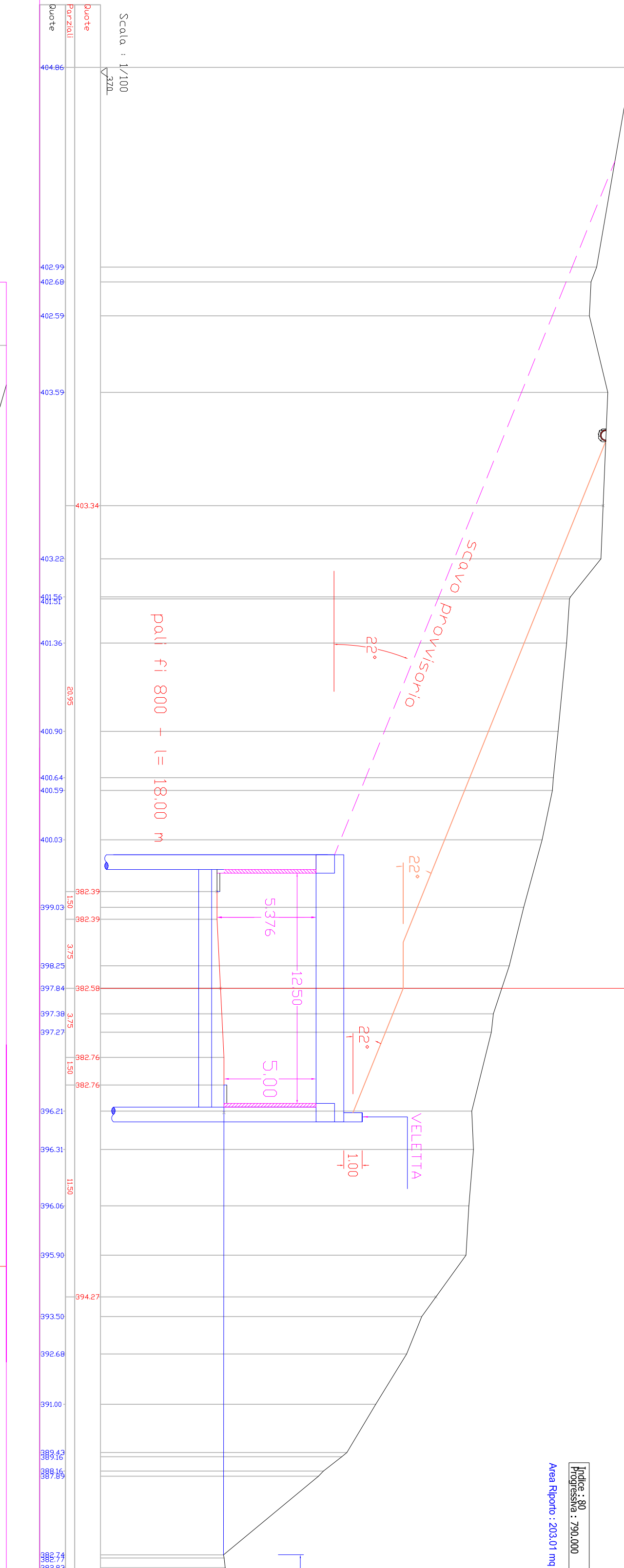
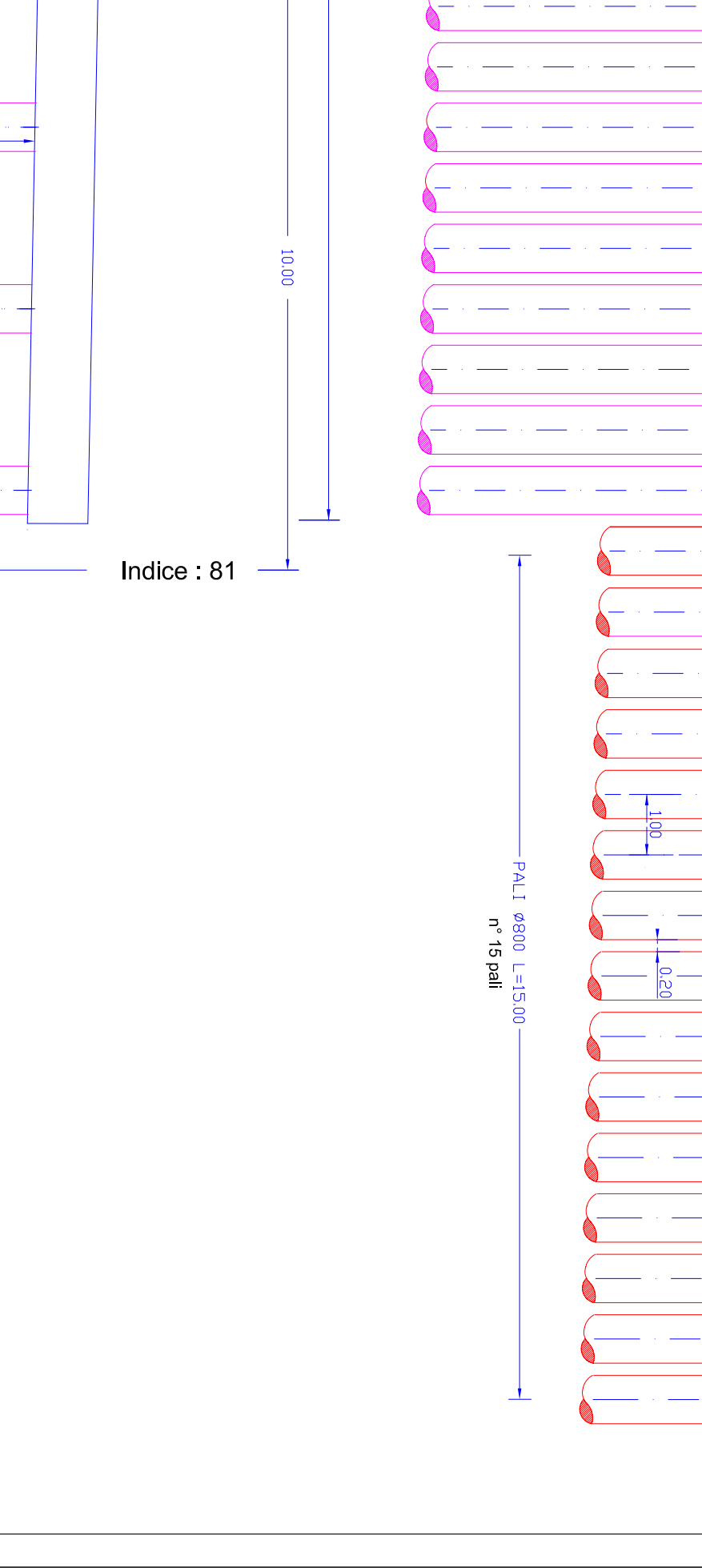
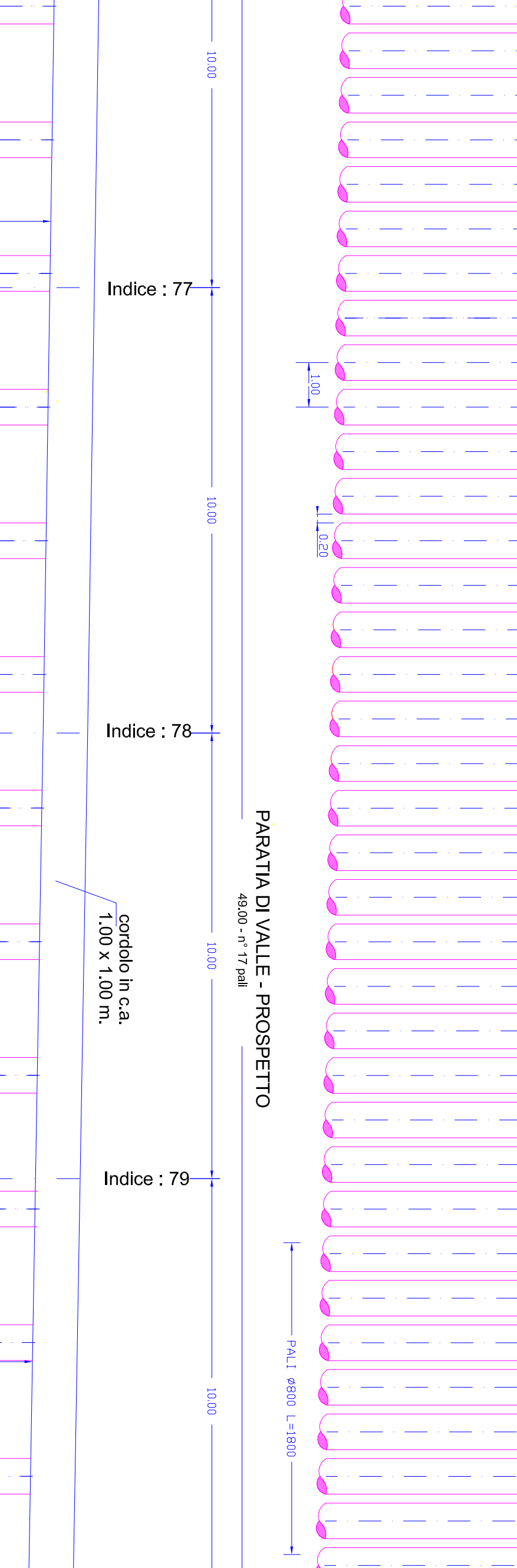
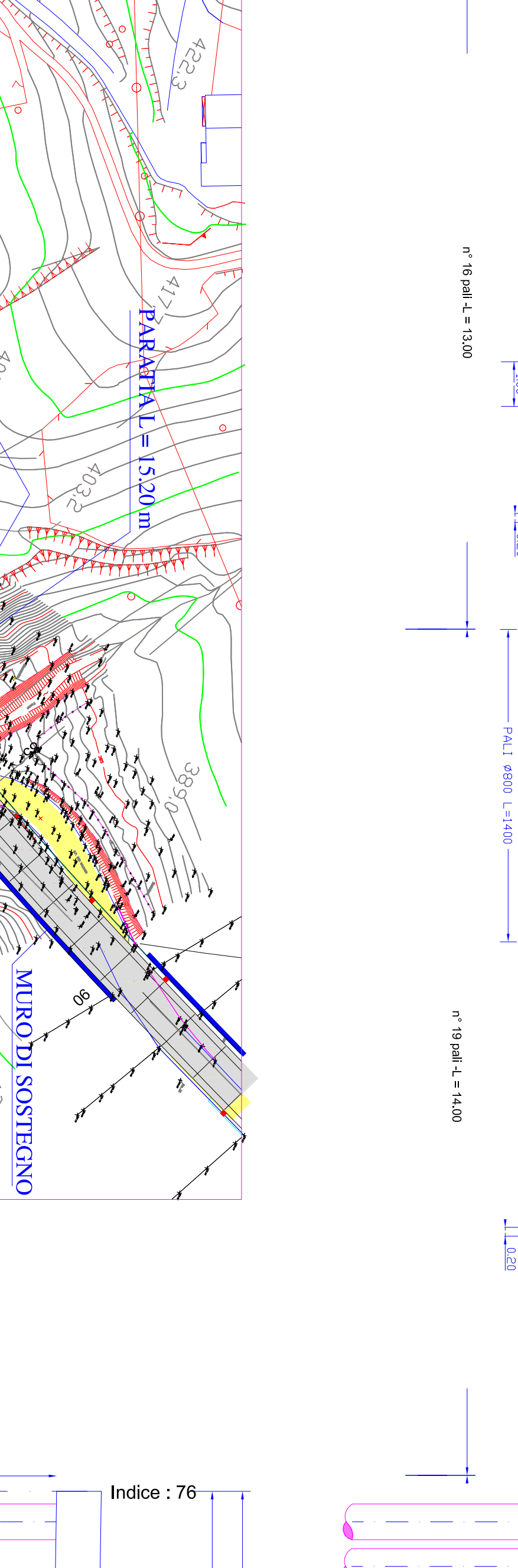
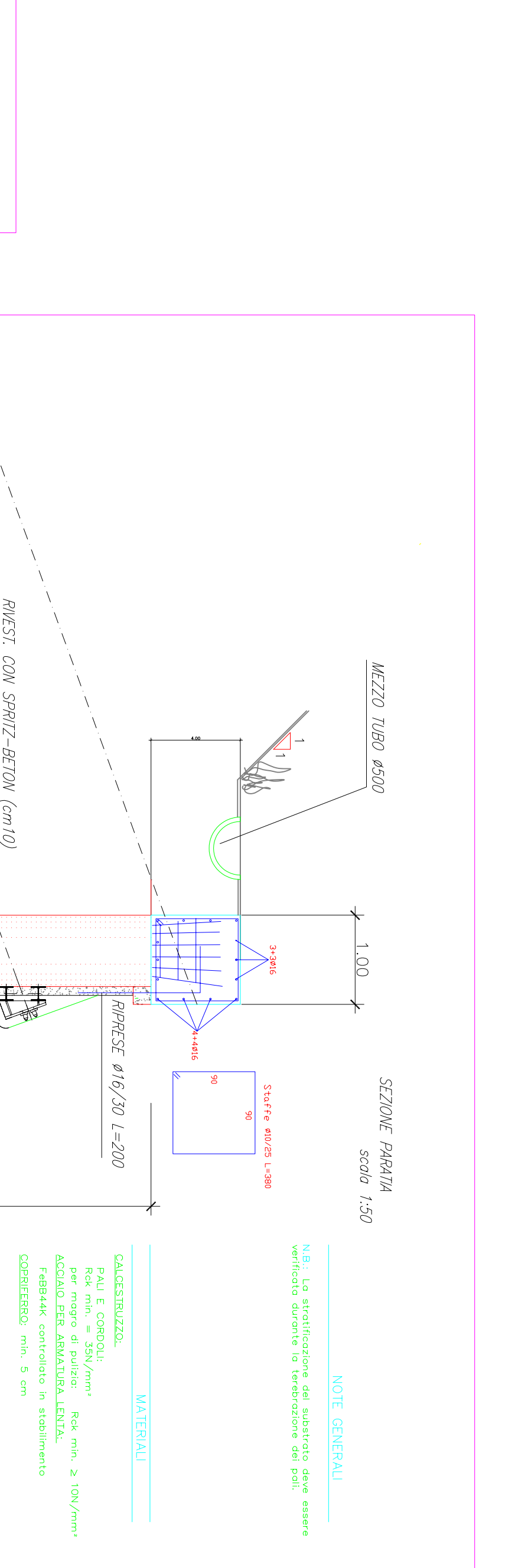
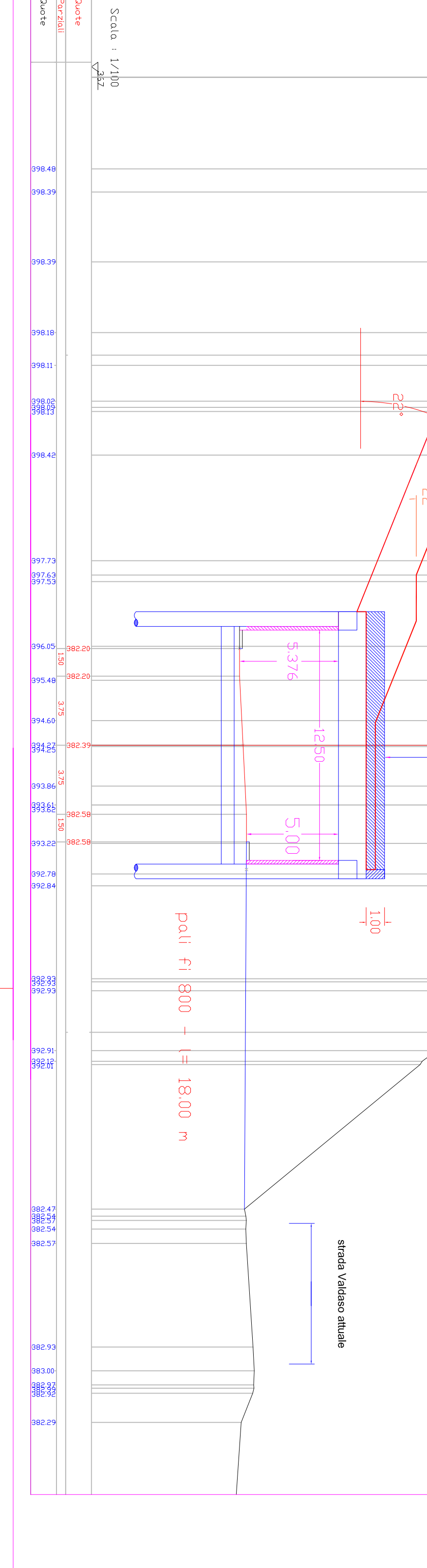
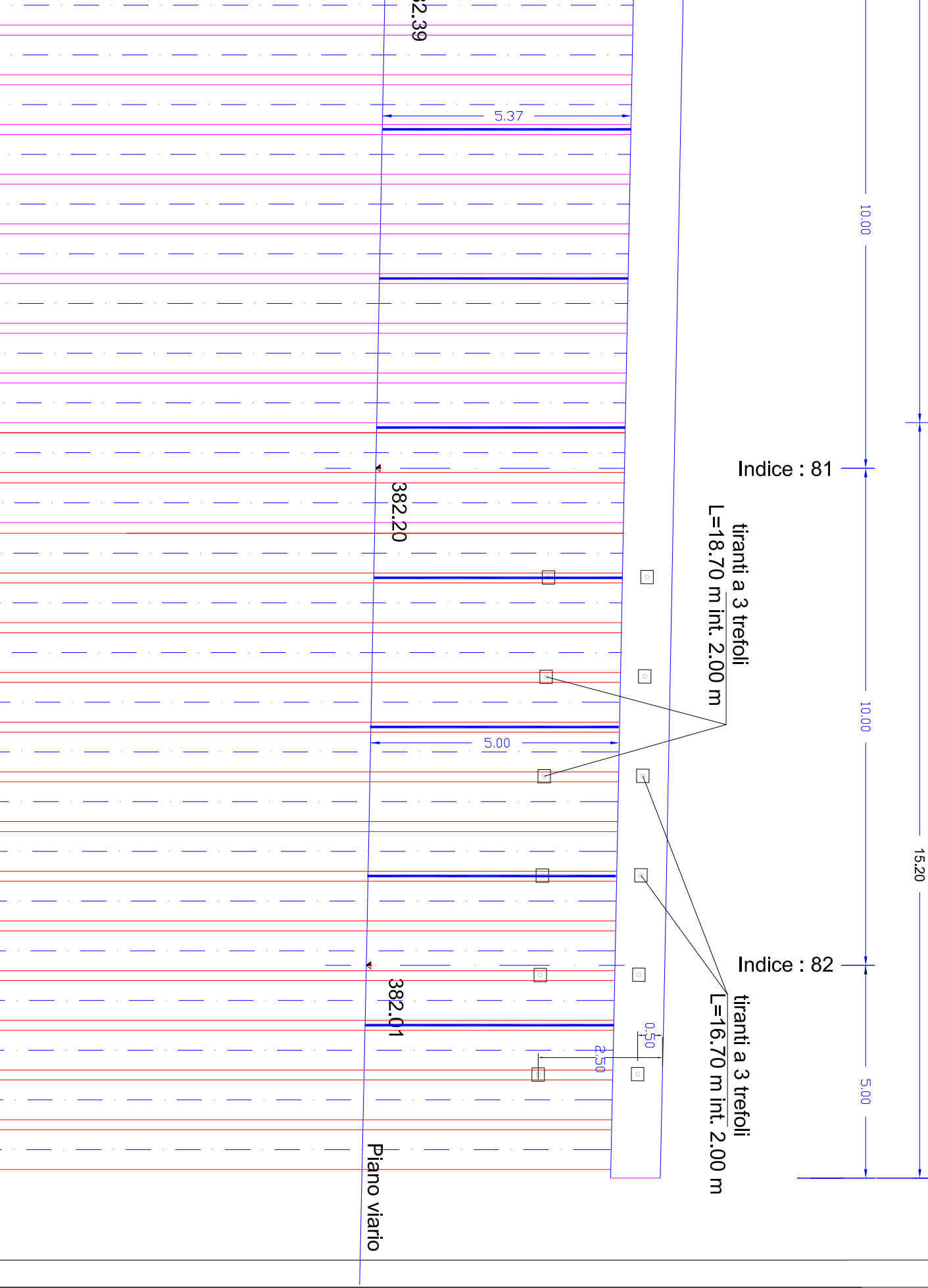
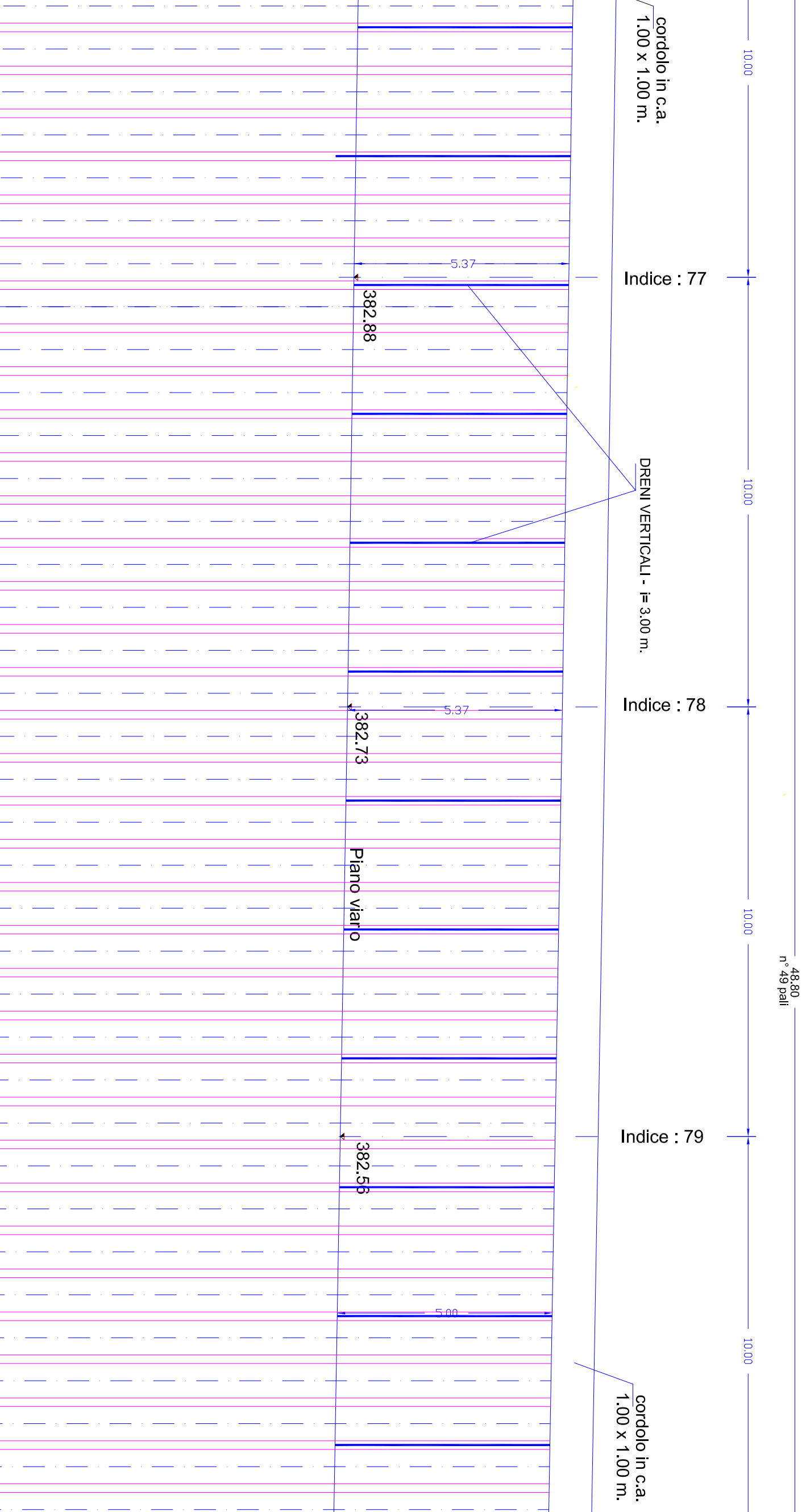
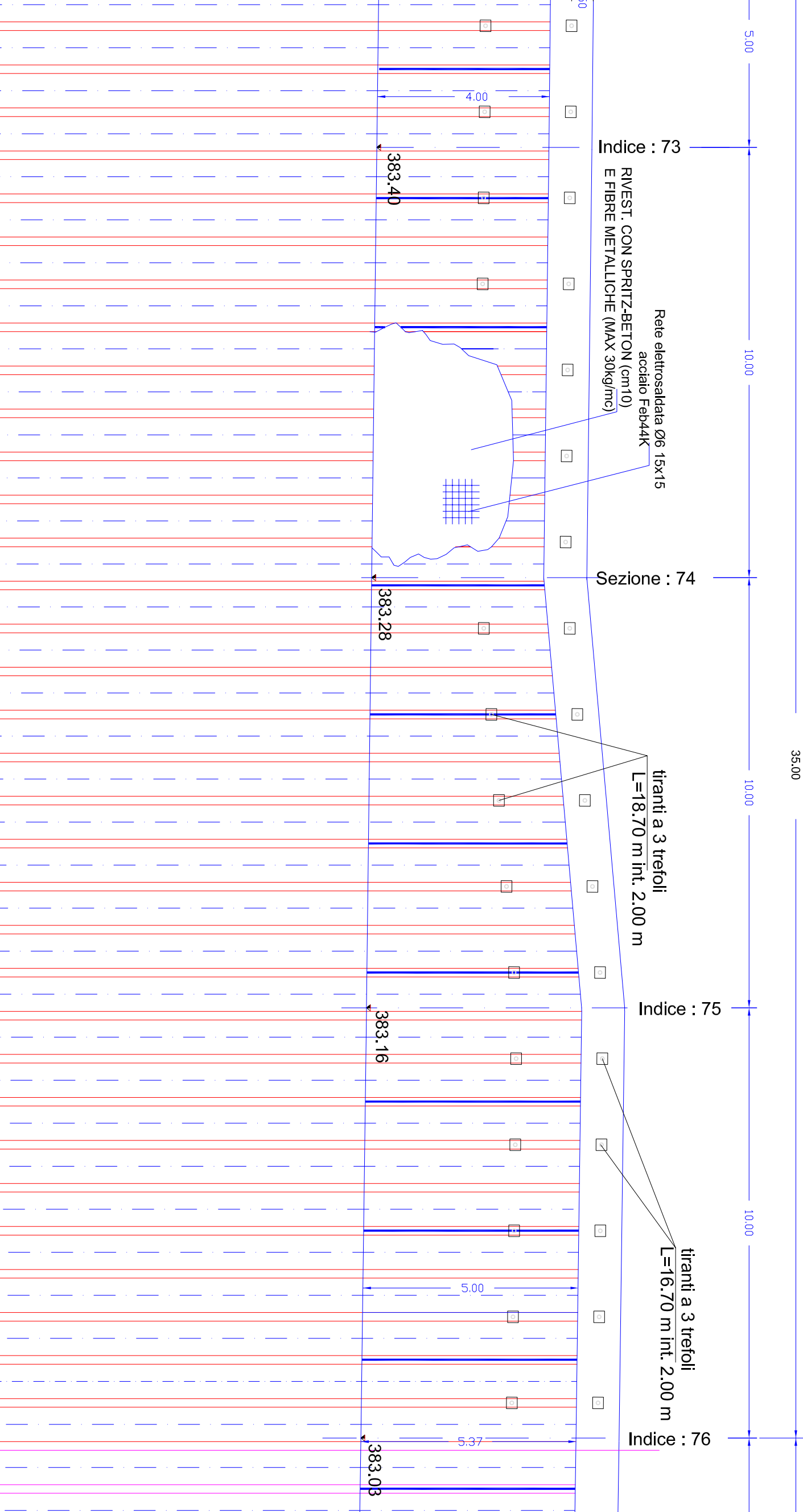
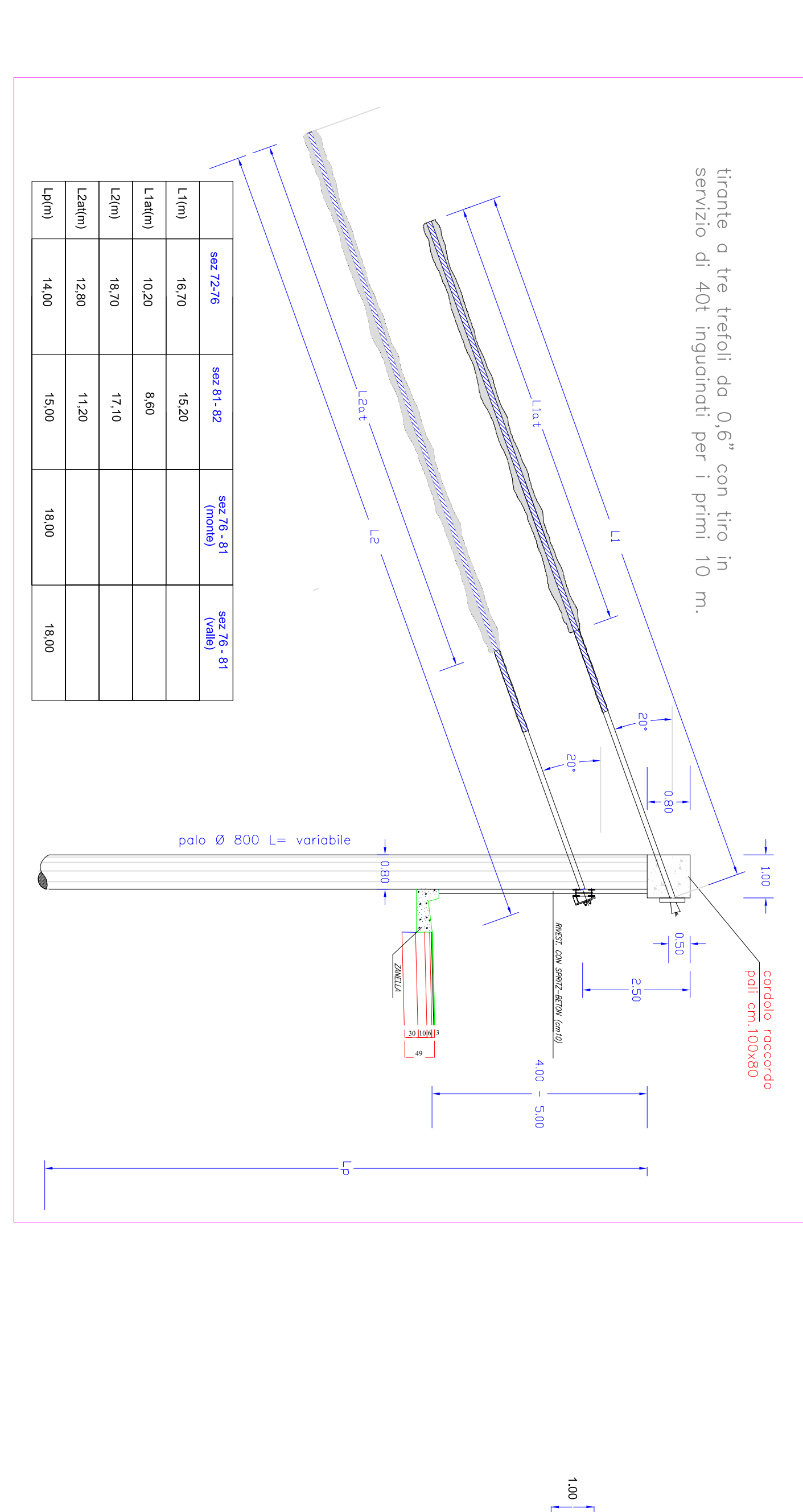
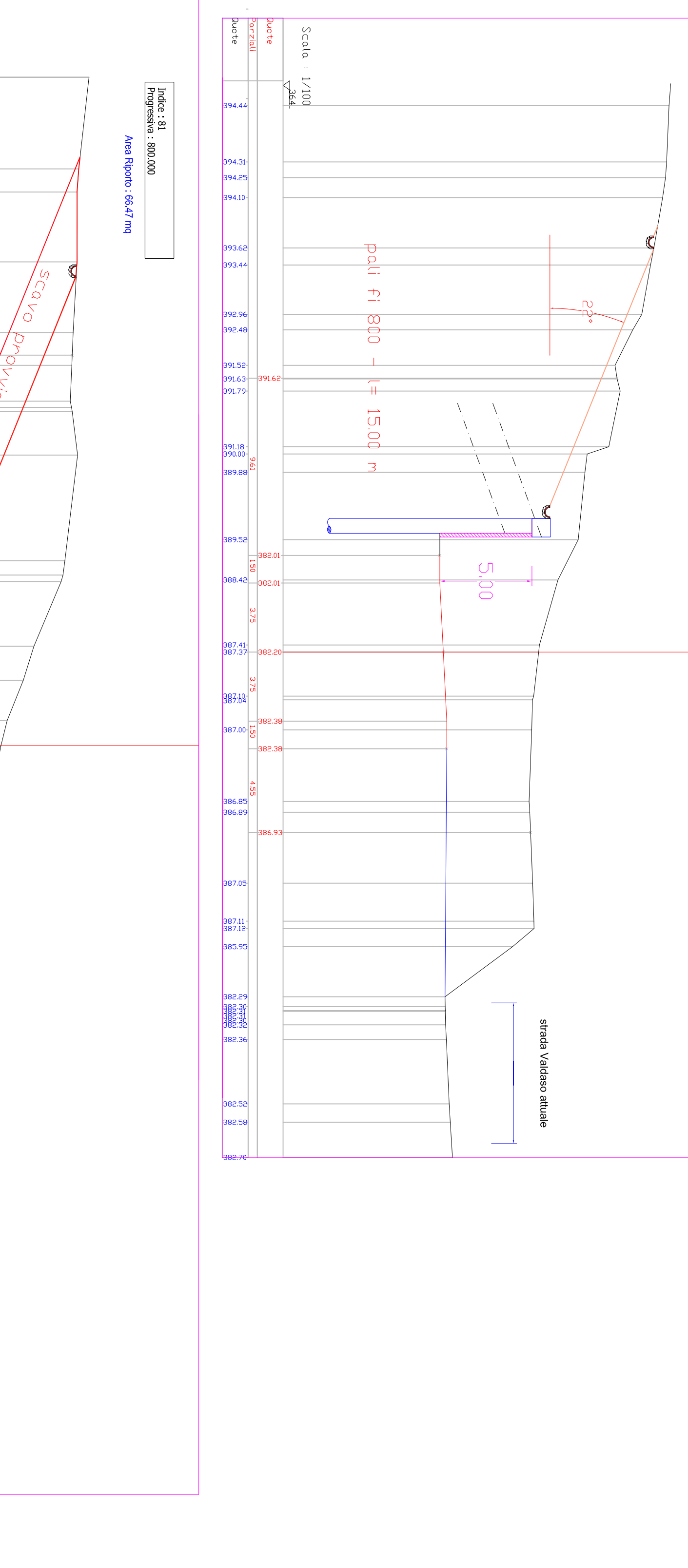
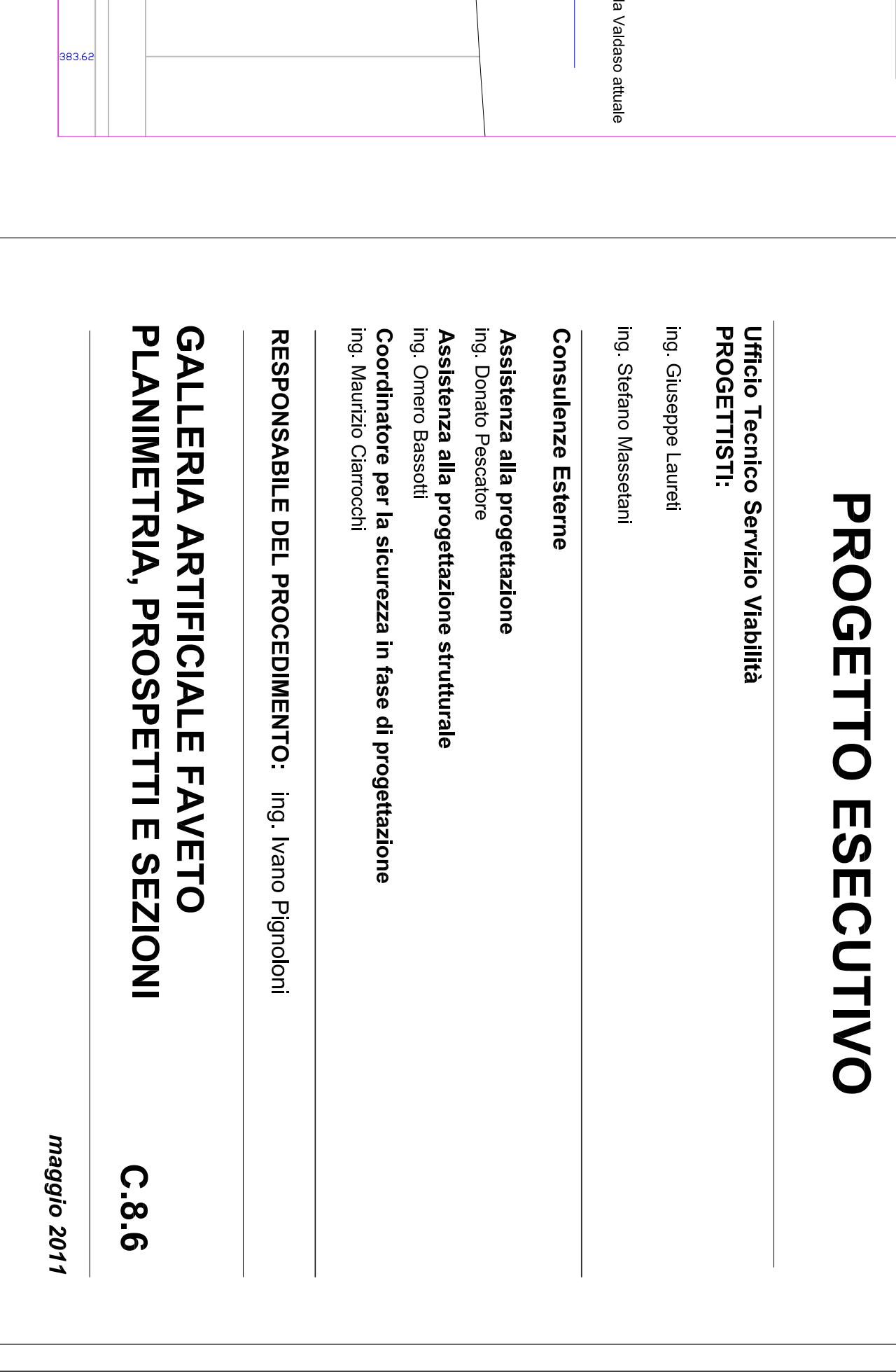
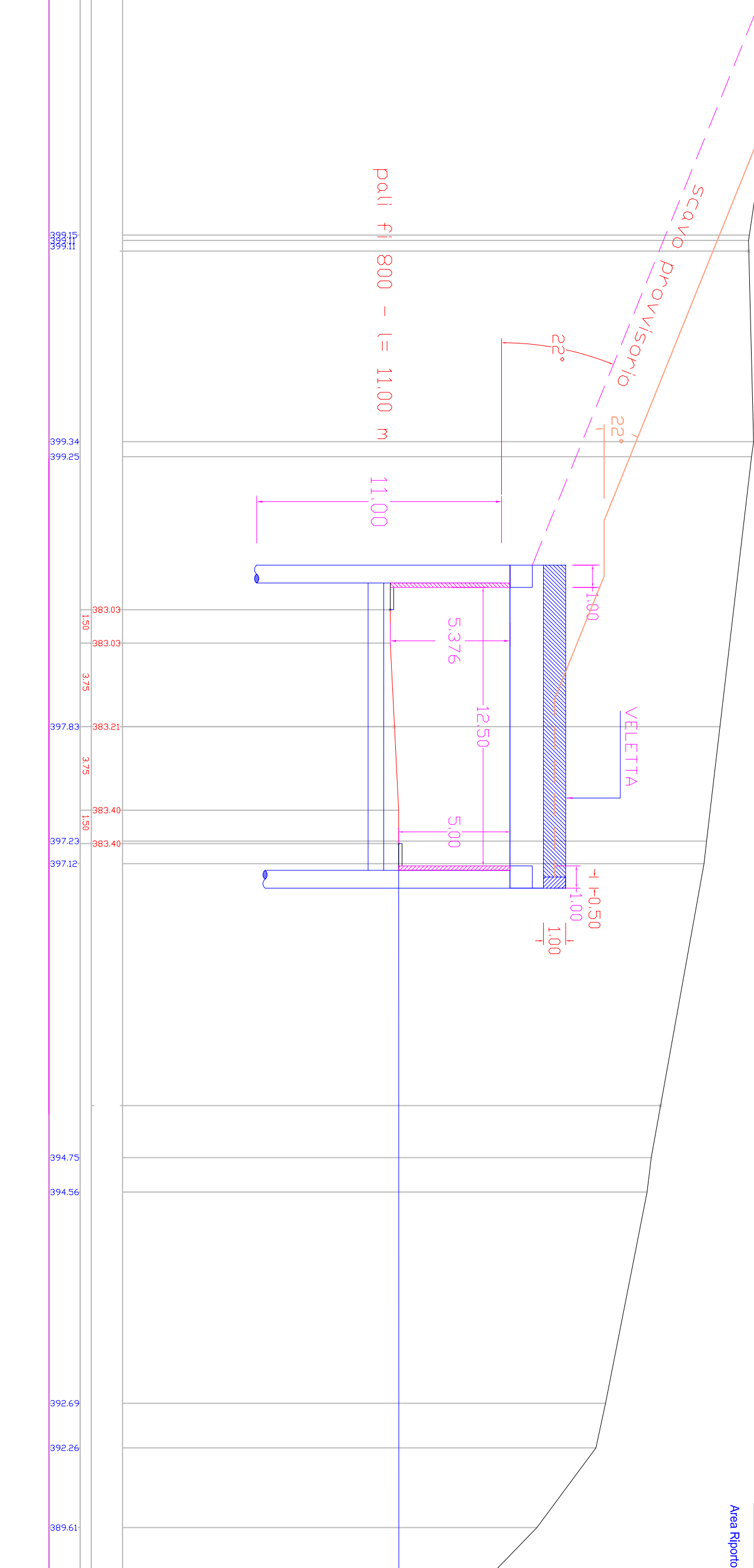
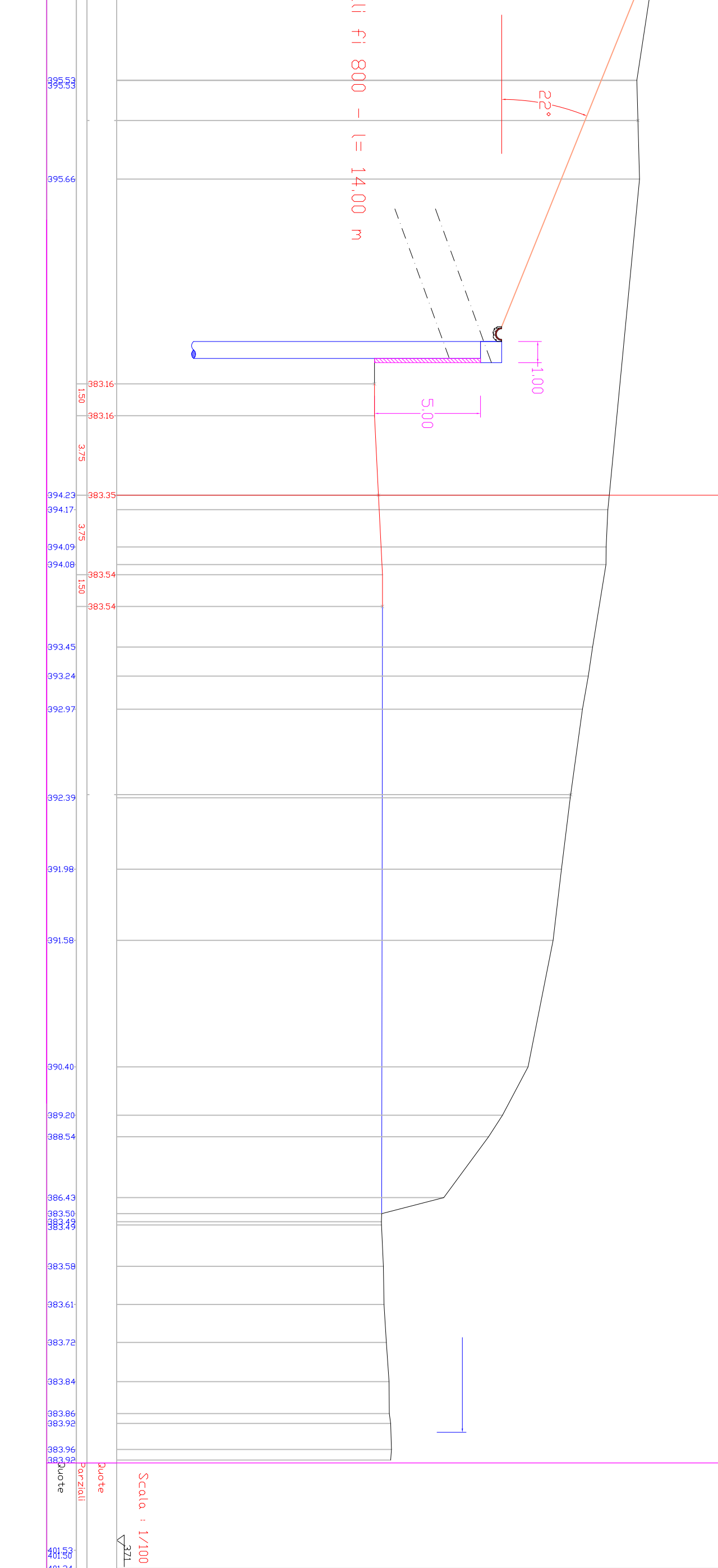
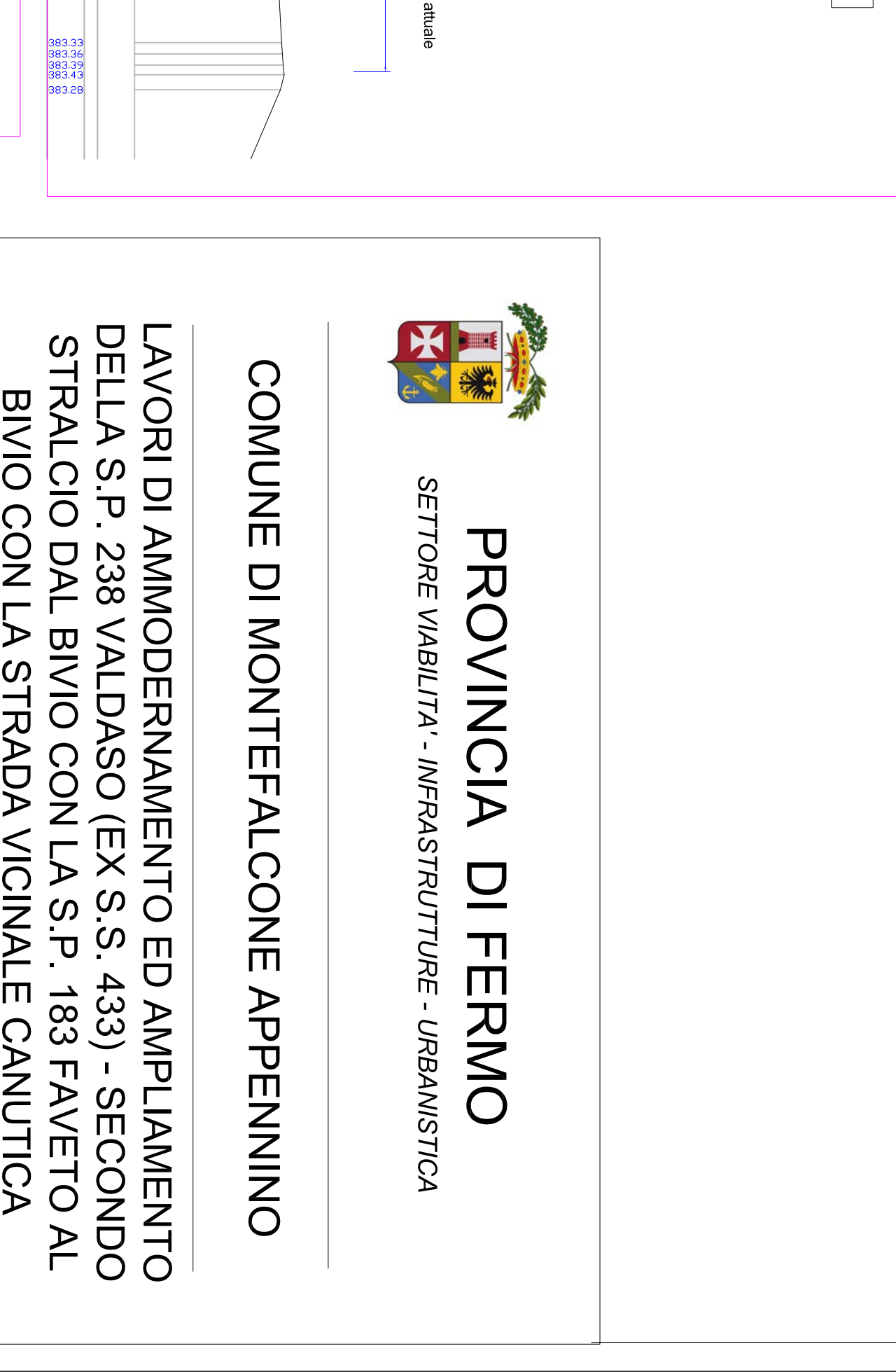
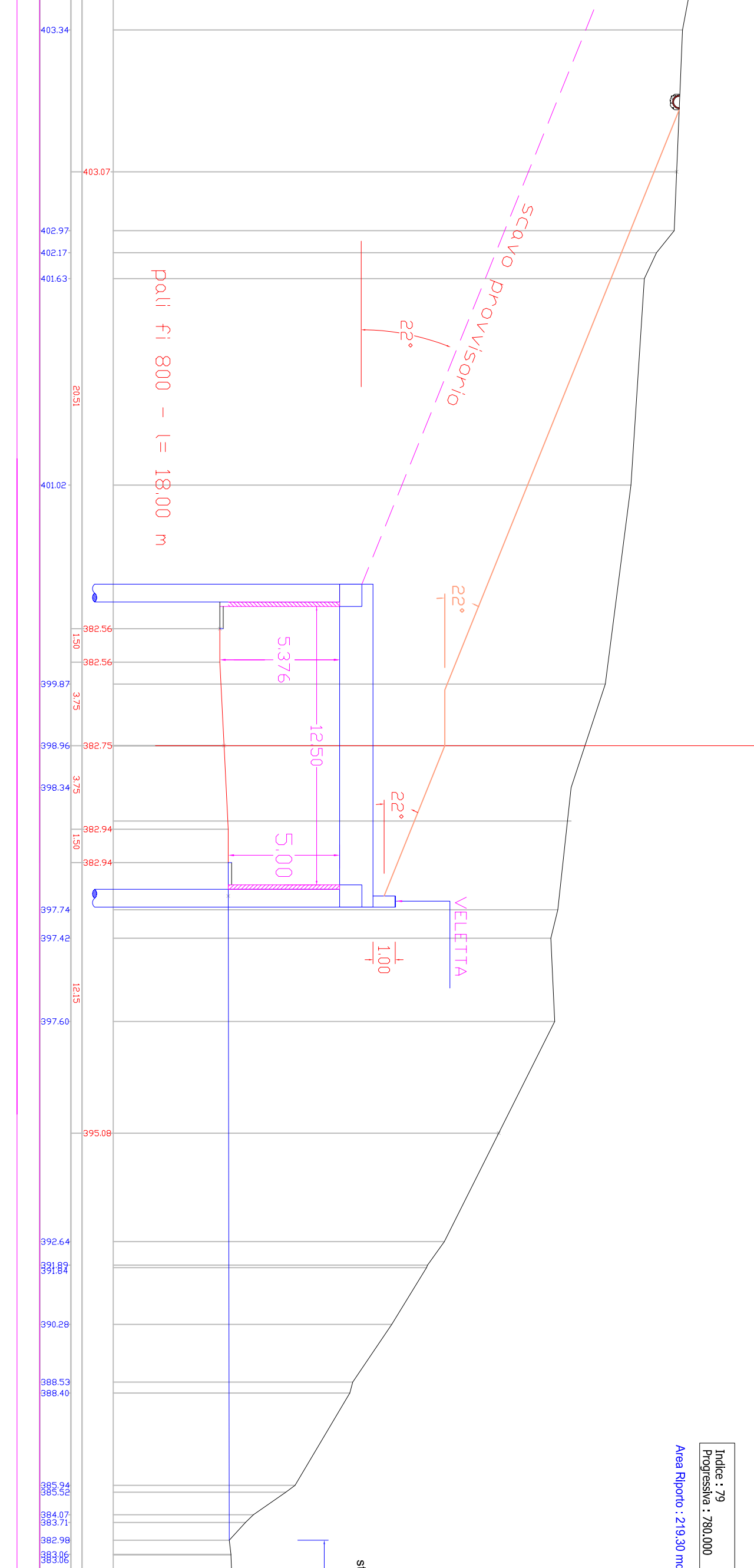
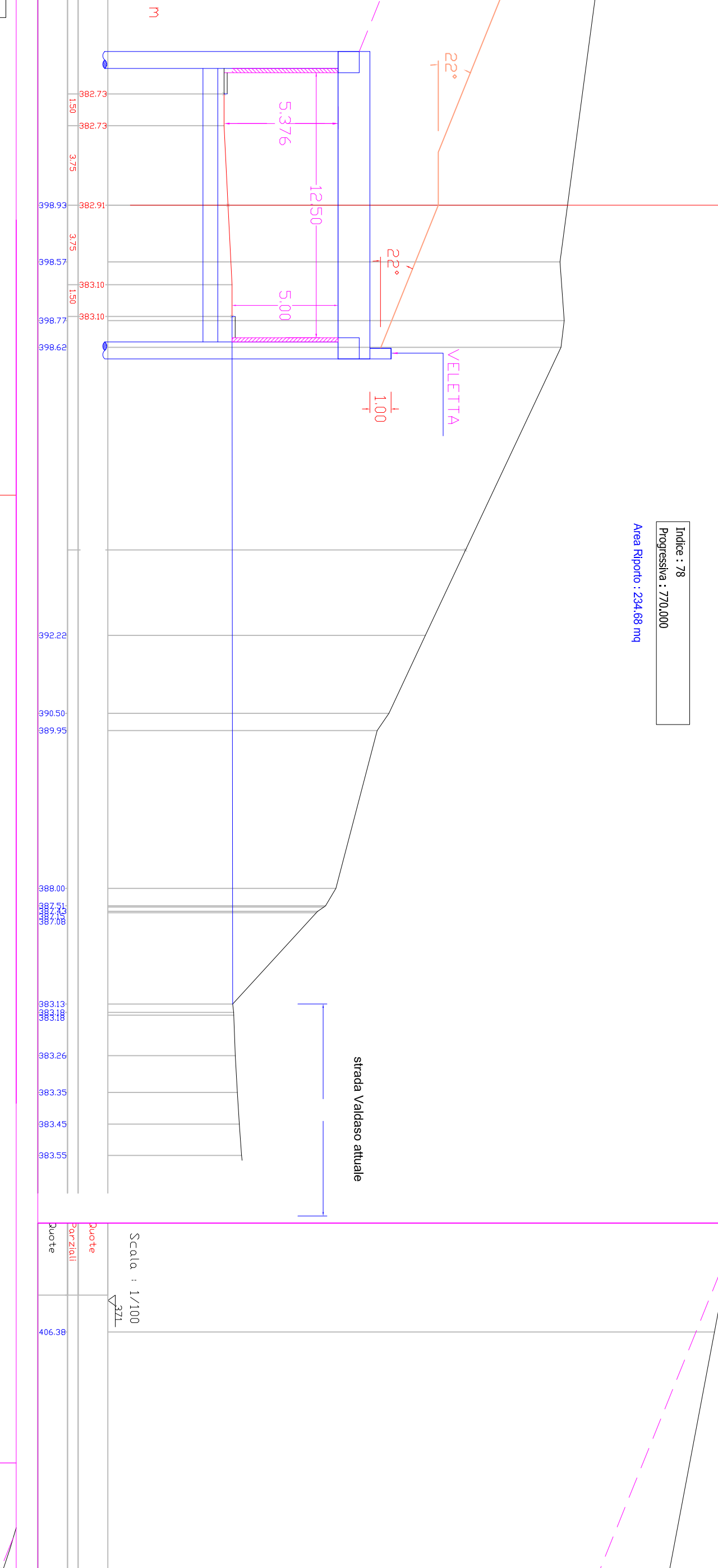
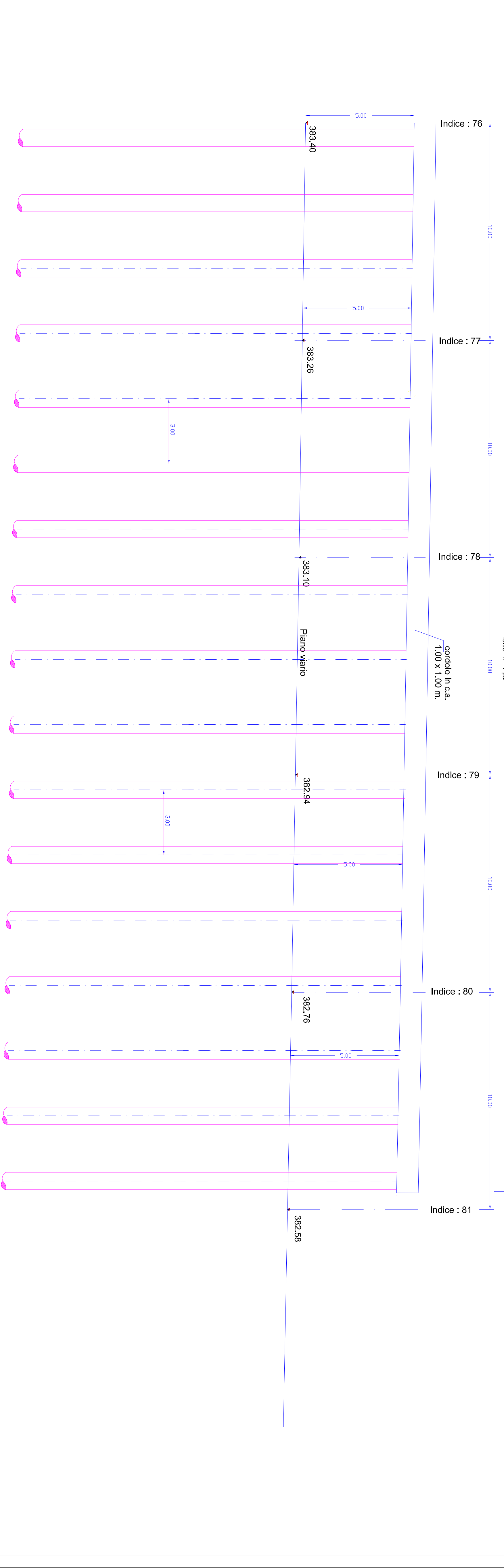
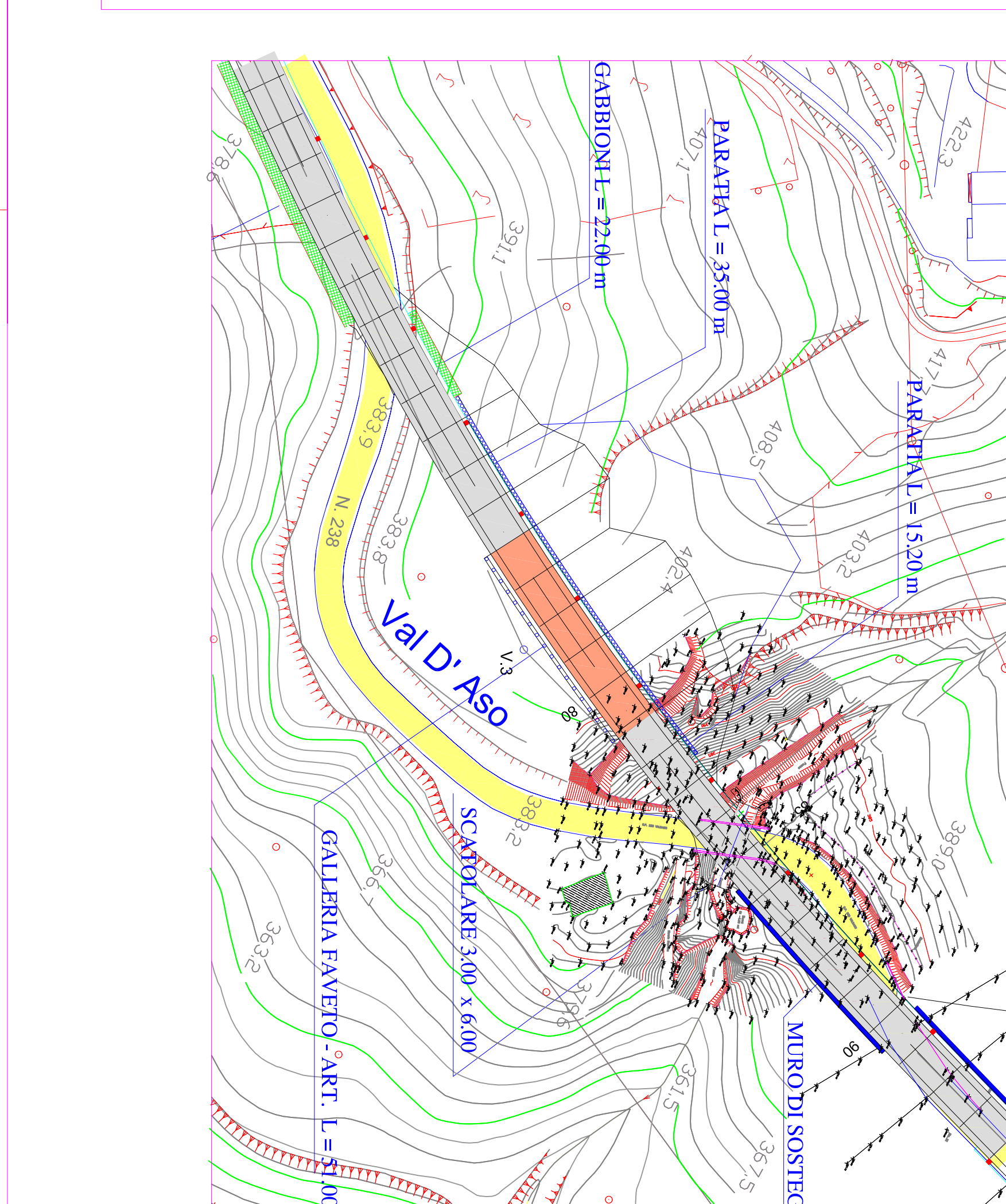
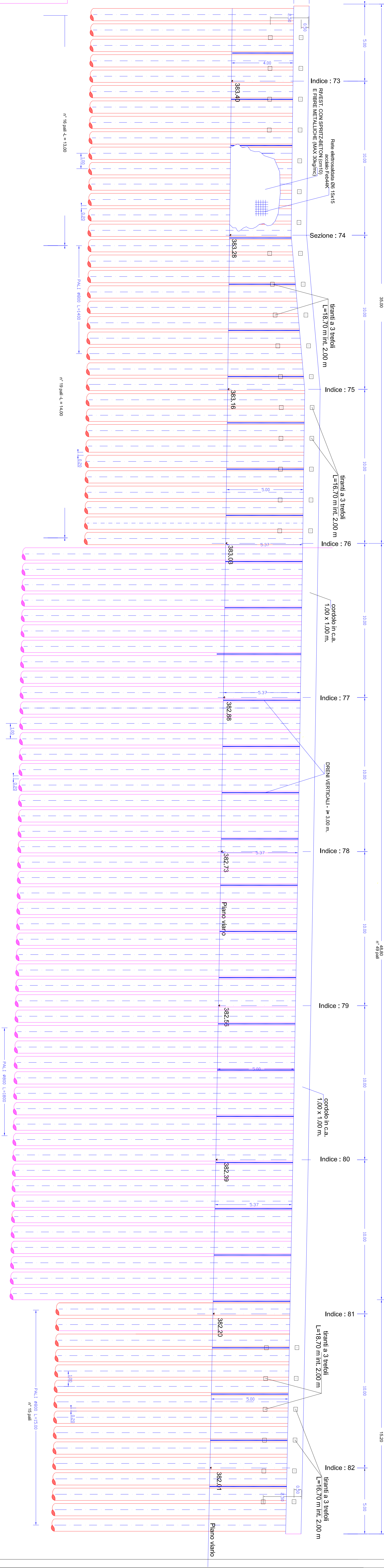

PROVINCIA DI FERMO
SETTORE VIABILITA' - INFRASTRUTTURE - URBANISTICA

COMUNE DI MONTEFALCONE APPENNINO

LAVORI DI AMMODERNAMENTO ED AMPLIAMENTO DELLA S.P. 238 VALDASO (EX S.S. 433) - SECONDO STRALCIO DAL BIVIO CON LA S.P. 183 FAVETTO AL BIVIO CON LA STRADA VICINALE CANTUCCA

PROGETTO ESECUTIVO

Ufficio Tecnico Servizio Viabilità
PROGETTISTI:
Ing. Giuseppe Lazzari
Ing. Stefano Massimini
Consulenza Esterna
Assistenza alla progettazione
Assistenza alla progettazione strutturale
Coordinatore per la sicurezza in fase di progettazione
RESPONSABILE DEL PROCEDIMENTO: Ing. Bruno Pignatelli